

# Technical data sheet

Progressive cavity pumps VISCOPOWER F 570 / F 580



More than just pumps



### Advantages/features:

- ▶ Easy and fast disassembling of the wetted parts
- ▶ For operation in the food, cosmetics or pharmaceutical industry – versions conforming to FDA, EC 1935/2004 and 3-A available
- ▶ Ex versions available
- ▶ Standardized interfaces, modular system
- ▶ For use at max. 40°C ambient temperature and 100°C liquid temperature
- ▶ Wide range of applications



Ex-marking II 1/2 G Ex h IIB T4...T3 Ga/Gb

A wide range of preconfigured variants is already available for the most common applications and fields of use. For specific needs, media or special applications, the pump can be assembled from various modular building blocks tailored to your requirements.

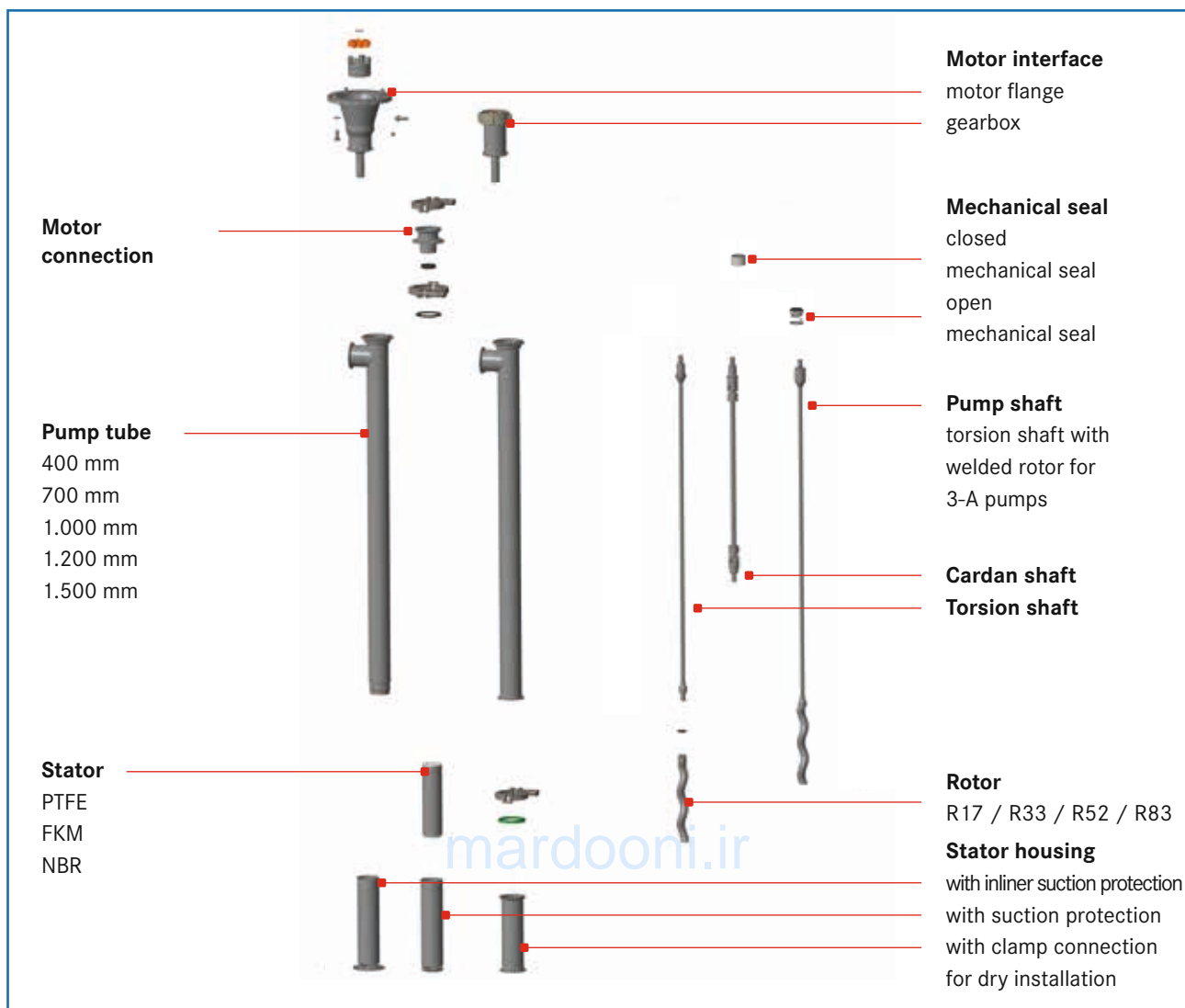

# Components

## VISCOPOWER

### Motor connection



#### F 570: gearbox variant

i = 16 gearbox

- double stage gearbox
- for use with air motors, commutator motors or brushless motors
- for media up to max. 30.000 mPas (depending on motor)
- lightweight – for mobile use

i = 7 gearbox

- single-stage gearbox
- for high-speed asynchronous motors
- for media up to 80.000 mPas
- with anti-rotation device to prevent the motor from rotating due to vibrations



#### F 580: motor flange variant

- for use with asynchronous motors, spur gear motors, air motors
- for thin to highly viscous, pasty media up to 100.000 mPas
- robust
- for stationary use
- in combination with VISCOFLUX mobile S also suitable for media that are not capable of flowing
- available with speed sensor for indirect, non-contact flow measurement



### Pump tube



material	stainless steel (1.4404)
outer diameter [mm]	53
outlet connection	clamp 2"
immersion depth [mm]	400, 700, 1.000, 1.200, 1.500
connection stator housing	thread Rd 51 x 1/8 LH for vertical use in extraction container – as drum pump 2" clamp connection for dry installation outside the container or in connection with a drum emptying system VISCOFLUX mobile S



### Stator housing



#### Stator housing with suction protection

connection to pump tube by thread Rd 51 x 1/8 LH



#### Stator housing with inliner suction protection

connection to pump tube by thread Rd 51 x 1/8 LH



#### Stator housing for dry-installed pumps

connection to pump tube by clamp 2"



### Mechanical seal

Sliding ring and counter ring made of silicon carbide, spring made of stainless steel

	Open mechanical seal	Closed mechanical seal
seal	FKM	FKM or FFKM
pressure [bar]	max. 10	max. 15
use / application	for industrial applications	for hygienic applications
approvals		*

\* 3-A only with closed mechanical seal in FKM



### Seal materials (O-rings)

	FKM	FFKM	NBR
characteristics	general good chemical resistance	for highest chemical resistance	for mineral oils
approvals			

### Pump shaft

	Torsion shaft	Cardan shaft
for pumps with immersion depth [mm]	700 (max. 4 Nm) 1.000 1.200 1.500	400 700 (from 4 Nm)
approvals		

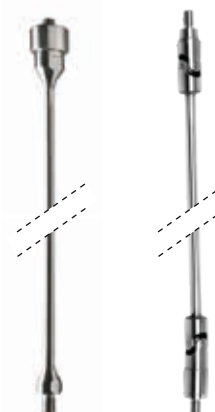

### Rotor /stator geometry

	R17	R33	R52	R83
max. flow rate [l/min] at 900 rpm	15	30	47	75
nominal volume per rotation [ml]	17	33	52	83
approvals				



### Stator materials

	PTFE	NBR white	FKM
characteristics	very good chemical resistance, ideal for food as well as for pharmaceutical and cosmetic products	for fuels, mineral oils, greases, vegetable and animal fats and oils, diluted acids, bases and salt solutions	very good chemical resistance
approvals			-

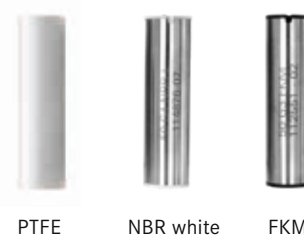

# Pumps

## VISCOPOWER F 570

F 570 - gearbox i = 16

### VISCOPOWER pumps F 570 - with double stage gearbox i = 16

Open mechanical seal, FKM seal, torsion shaft

immersion depth [mm]	rotor geometry	stator material	part no.
700	R33	PTFE	12-570 00 001
700	R52	PTFE	12-570 00 004
1.000	R17	PTFE	12-570 00 007
1.000	R33	PTFE	12-570 00 002
1.000	R52	PTFE	12-570 00 005
1.000	R83	PTFE	12-570 00 009
1.200	R17	PTFE	12-570 00 008
1.200	R33	PTFE	12-570 00 003
1.200	R52	PTFE	12-570 00 006
1.200	R83	PTFE	12-570 00 010



Open mechanical seal, NBR seal, torsion shaft

immersion depth [mm]	rotor geometry	stator material	part no.
1.000	R33	NBR white	12-570 00 011
1.000	R52	NBR white	12-570 00 013
1.200	R33	NBR white	12-570 00 012
1.200	R52	NBR white	12-570 00 014

Open mechanical seal FKM seal, torsion shaft, with ex-approval

Ex marking II 1/2 G Ex h IIB T4...T3 Ga/Gb



immersion depth [mm]	rotor geometry	stator material	part no.
1.000	R33	PTFE ATEX	12-570 00 021
1.200	R33	PTFE ATEX	12-570 00 022

Closed mechanical seal, FKM seal, torsion shaft,

for food contact according to EC 1935/2004 and FDA CFR 21



Immersion depth [mm]	rotor geometry	stator material	3-A	part no.
1.000	R33	PTFE	no	12-570 00 015
1.000	R52	PTFE	no	12-570 00 017
1.200	R33	PTFE	no	12-570 00 016
1.200	R52	PTFE	no	12-570 00 018
1.000	R33	PTFE	yes	12-570 00 019
1.000	R52	PTFE	yes	12-570 00 020



mardooni.ir

# Drive motors

for VISCOPOWER F 570



## Appropriate drive motors for VISCOPOWER F 570 with double stage gearbox $i = 16$

Motors 230 V, 50 Hz, 5 m cable and plug



Commutator motor  
FEM 4070



Commutator motor  
F 457



Commutator motor  
F 458 / F 458-1 /  
F 458 EL



Commutator motor  
F 460 Ex / F 460-1 Ex /  
F 460 Ex EL



Brushless motor  
FBM 4000 Ex

F 570 – gearbox  $i = 16$

type	capacity [watt]	protection class	max. viscosity [mPas]	weight [kg]	part no. with no-volt release	part no. without no-volt release
FEM 4070	500	IP 24	10.000	2,6	10-407 01 000	10-407 01 001
F 457	800	IP 24	30.000	4,0	10-457 01 005	10-457 01 002
F 458	460	IP 55	12.000	5,1	10-458 00 006	10-458 00 001
F 458 EL*	460	IP 55	12.000	5,1	10-458 00 027	-
F 458-1	700	IP 55	25.000	5,9	10-458 01 004	10-458 01 001
F 460 Ex	460	IP 55	12.000	5,1	10-460 00 006	10-460 00 001
F 460 Ex EL*	460	IP 55	12.000	5,1	10-460 00 028	-
F 460-1 Ex	700	IP 55	25.000	5,9	10-460 01 004	10-460 01 001
FBM 4000 Ex	600	IP 55	20.000	6,1	10-400 01 000	10-400 01 000

EL\* = version with electronic speed adjustment

## Compressed-air motors explosion-proof, max. operation pressure 6 bar, G 1/4" female connection for air hose



F 416 Ex



F 416-1 Ex



F 416-2 Ex

type	capacity [watt]	max. viscosity [mPas]	version	weight [kg]	part no.
F 416 Ex	470	30.000	with tilt valve	1,4	10-416 00 100
F 416-1 Ex	470	30.000	without valve	0,9	10-416 00 020
F 416-2 Ex	470	30.000	with ball valve	1,0	10-416 00 030

accessories	part no.
filter-regulator-lubricator unit, G 1/4" female connection, for non-hazardous areas	10-001 10 100
filter-regulator-lubricator unit, G 1/4" female connection, explosion-proof	10-001 10 113
compressed-air hose, electrically conductive, DN 10, sold by meter	10-001 10 098
hose coupling in brass, for hose DN 10	10-959 13 066
threaded nipple in brass for hose coupling, G 1/4" male	10-959 13 065
hose nozzle in brass for air hose DN 10 – G 1/4" male	10-959 05 022
plug-in sleeve DN 10	10-959 13 209
1-ear hose clip $\varnothing$ 14,8; clamping range 8 - 18 mm	10-959 13 237

Further accessories for drive motors can be found in our detailed FLUX Accessories brochure.

# Pumps and drive motors

## VISCOPOWER F 570

F 570 – gearbox i = 7

### VISCOPOWER pumps F 570 - with single-stage gearbox i = 7

Open mechanical seal, FKM seal, torsion shaft

immersion depth [mm]	rotor geometry	stator material	part no.
1.000	R33	PTFE	12-570 00 024
1.000	R52	PTFE	12-570 00 023



### Appropriate motors F 403

Single phase AC motor, 230 V, 50 Hz, IP 55, with motor protection switch, 5 m cable and plug

rpm	capacity [kW]	weight [kg]	part no.
3.000	0,5	9,0	10-403 01 023
1.500	0,55	11,0	10-403 01 024

Three-phase motor, 230/400 V, 50 Hz

	rpm	capacity [kW]	weight [kg]	part no.
motor protection switch	1.500	0,55	8,7	10-403 01 025
motor protection switch	3.000	0,75	10,2	10-403 01 026
cable terminal box	1.500	0,55	12,0	10-403 01 027 <sup>1</sup>
cable terminal box	3.000	0,75	13,7	10-403 01 029 <sup>1</sup>



image similar

<sup>1</sup> Ex II 2G Ex eb IIC T3 Gb

### VISCOPOWER pumps F 580 - with motor flange

Open mechanical seal, FKM seal

immersion depth [mm]	rotor geometry	stator material	shaft	part no.
700	R33	PTFE	cardan	12-580 00 001
700	R52	PTFE	cardan	12-580 00 004
1.000	R33	PTFE	torsion	12-580 00 002
1.000	R52	PTFE	torsion	12-580 00 005
1.000	R83	PTFE	torsion	12-580 00 007
1.200	R33	PTFE	torsion	12-580 00 003
1.200	R52	PTFE	torsion	12-580 00 006
1.200	R83	PTFE	torsion	12-580 00 008

Open mechanical seal, NBR seal, torsion shaft

immersion depth [mm]	rotor geometry	stator material	part no.
1.000	R17	NBR white	12-580 00 009
1.000	R33	NBR white	12-580 00 011
1.200	R17	NBR white	12-580 00 010
1.200	R33	NBR white	12-580 00 012

Open mechanical seal, FKM seal, torsion shaft, ex-protected

Ex marking II 1/2 G Ex h IIB T4...T3 Ga/Gb



immersion depth [mm]	rotor geometry	stator material	part no.
1.000	R33	PTFE ATEX	12-580 00 017
1.200	R33	PTFE ATEX	12-580 00 018

Closed mechanical seal, FKM seal, torsion shaft

for food contact according to EC 1935/2004 and FDA CFR 21



immersion depth [mm]	rotor geometry	stator material	3-A	part no.
1.000	R52	PTFE	no	12-580 00 013
1.200	R52	PTFE	no	12-580 00 014
1.000	R33	PTFE	yes	12-580 00 015
1.000	R52	PTFE	yes	12-580 00 016



VISCOPOWER pumps immersion depth 400 mm, cardan shaft, PTFE stator, with clamp 2" connection at the stator housing for dry installation, e.g. assembly on pump trolley or console

immersion depth [mm]	rotor geometry	mechanical seal	FOOD	part no.
400	R52	FKM open	no	12-580 00 019
400	R52	FKM open	no	12-580 00 021
400	R52	FKM closed	yes	12-580 00 020



mardooni.ir

# Drive motors

## VISCOPOWER

F 580

### Appropriate drive motors for VISCOPOWER F 580 – with flange connection

Three-phase motor, 230/400 V, 50 Hz



	rpm	capacity [kW]	protection class	weight [kg]	part no.
motor protection switch	750	0,75	IP 55	21,5	10-001 01 590
motor protection switch	750	1,1	IP 55	23,0	10-001 01 591
motor protection switch	1.000*	0,75	IP 55	16,5	10-001 03 443
motor protection switch	1.000*	1,1	IP 55	25,0	10-001 03 445
cable terminal box	750	0,75	IP 55	22,5	10-001 01 588
cable terminal box	750*	1,1	IP 55	22,5	10-001 01 589
cable terminal box	1.000*	0,75	IP 55	19,0	10-001 03 442
cable terminal box	1.000*	1,1	IP 55	23,0	10-001 03 444
cable terminal box	750	0,95	IP 55	28,0	10-001 01 592 
cable terminal box	1.000	0,75	IP 55	19,0	10-001 01 119 
cable terminal box	1.000	1,1	IP 55	19,0	10-001 01 120 



image with cable terminal box - similar

Ex-marking : Ex II 2G Ex eb IIC T3 Gb

Spur gear motor, 380 - 500 V, 50/60 Hz, 1,6 A, without foot flange

	rpm	capacity [kW]	protection class	weight [kg]	part no.
with frequency regulation	47 - 472	0,55	IP 54	12,2	10-001 02 178





image similar

Start / stop switch for spur gear motor with frequency regulation and attached set point adjuster

	part no.
switching voltage 24 V DC, IP 66, with 1 m spirale cable with Hirschmann plug	10-936 00 040

Compressed-air motor, explosion-proof, with silencer

	rpm	capacity [kW]	weight [kg]	part no.
FPM 4 Ex 	1.000	0,6	4,7	10-001 04 000
FPM 6 Ex 	1.000	1,2	6,6	10-001 04 014
FPM 8 Ex 	1.000	2,0	11,3	10-001 04 002



FPM 4 Ex

\* efficiency class IE3  
version in stainless steel on request



# Dimensions

VISCOPOWER



## Pump tube

outer diameter pump tube [mm]	length stator housing [mm]	outlet connection
53	with thread connection: 224 with clamp connection: 214	clamp DN 50 / 2" (acc. to DIN 32676)

## Total lengths

immersion depth [mm]	gearbox variant F 570 i = 16	gearbox variant F 570 i = 7	motor flange variant F 580
400	610,3 (TR - clamp)	590,3 (TR - clamp)	638 (TR - clamp)
700	920,3	900,2	948
1.000	1.220,3	1.200,3	1.248
1.200	1.420,3	1.400,3	1.448
1.500	1.720,3	1.700,3	1.748

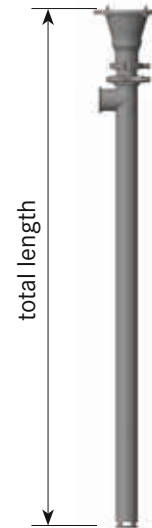

Dimensions

**Drive motors** for F 570 VISCOPOWER pumps with double stage gearbox i = 16

All dimensions in mm. When motor and pump are mounted, the total height is reduced by 16 mm.

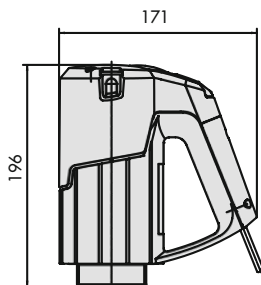

FEM 4070

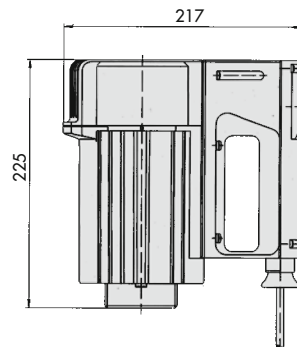

F 457

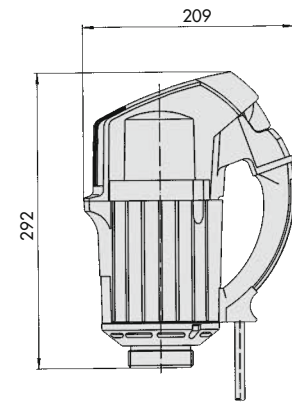

F 458/F 458 EL/F 458-1/  
F 460 Ex/F 460 Ex EL/  
F 460-1 Ex  
FBM 4000 Ex

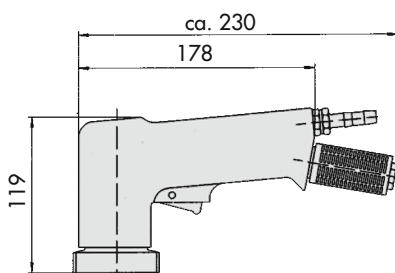

F 416 Ex

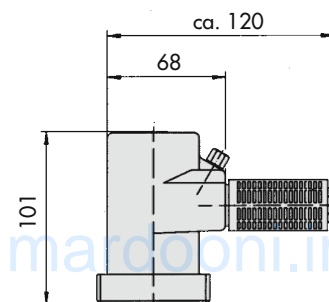

F 416-1 Ex

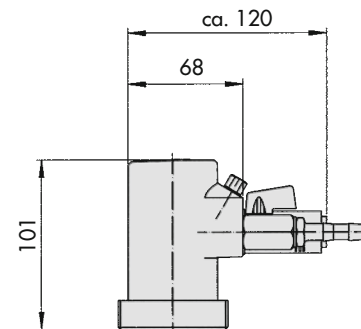

F 416-2 Ex

# Dimensions

## Drive motors for F 580 VISCOPOWER pumps with motor flange

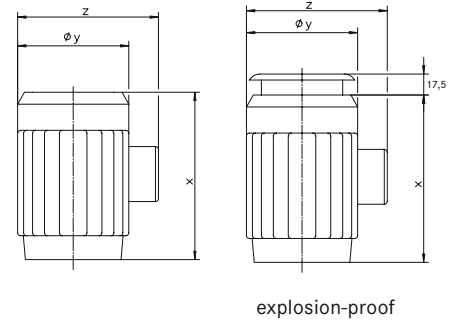

### Three-phase motors

rpm	capacity [kW]	X [mm]	Y [mm]	Z [mm]	part no.
750	0,75	343,50	198	318,5	10-001 01 590
750	1,1	378,50	198	319	10-001 01 591
1.000	0,75	305	178	291	10-001 03 443
1.000	1,1	345	178	291,50	10-001 03 445
750	0,75	343,50	198	264	10-001 01 588
750	1,1	343,50	198	265	10-001 01 589
1.000	0,75	305	178	215	10-001 03 442
1.000	1,1	345	178	215,5	10-001 03 444
750	0,95	328,50	195	263	10-001 01 592
1.000	0,75	274	177	245	10-001 01 119
1.000	1,1	299	177	245	10-001 01 120



explosion-proof

### Compressed-air motors

type	rpm	capacity [kW]	X [mm]	connection D
FPM 4 Ex 	1.000	0,5	117	G 3/8
FPM 6 Ex 	1.000	1,1	155	G 1/2
FPM 8 Ex 	1.000	1,8	177	G 1/2

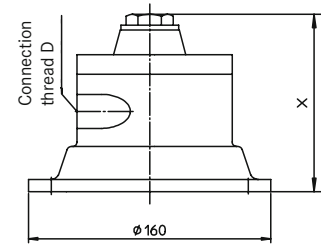

### Accessories

#### Outlet adapter, FKM seal and hinged clamp

	part no.
clamp 2" to G 1/2 external thread	11-000 00 159
clamp 2" to G 1 external thread	11-000 00 160
clamp 2" to G 1 1/2 external thread	11-000 00 161
clamp 2" to RD 58x1 1/2 external thread	11-000 00 162
clamp 2" to RD 65x1 1/2 external thread	11-000 00 163



Performance chart VISCOPOWER at 1 mPas with PTFE stator

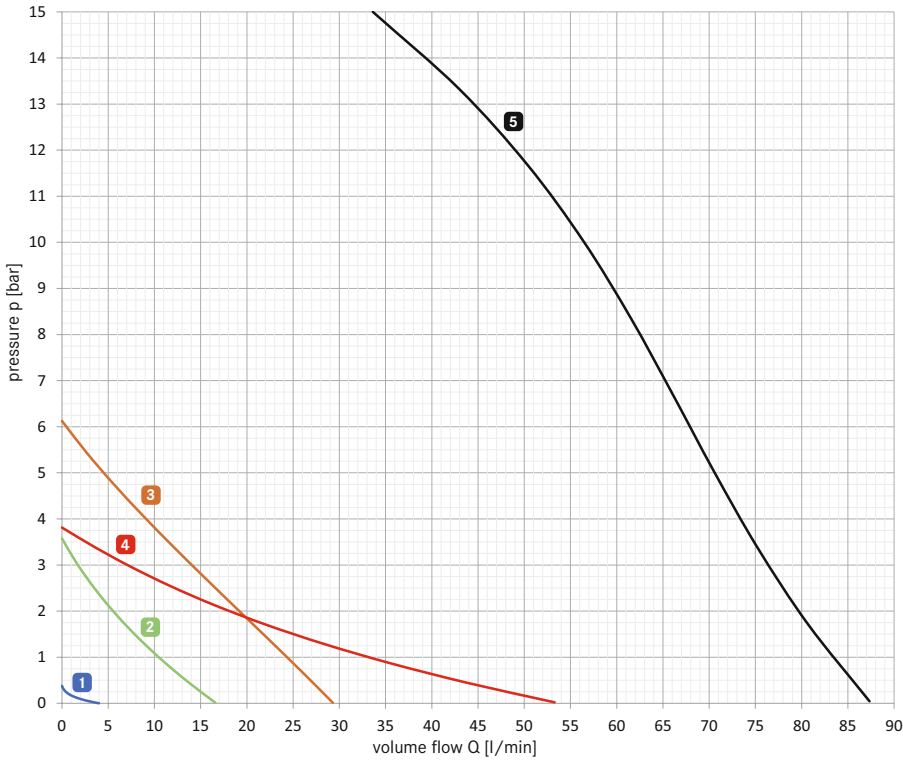

	rotor/stator geometry	rpm
1	R17	250
2	R17	1.000
3	R33	1.000
4	R52	1.000
5	R83	1.000

Performance chart VISCOPOWER at 1.000 mPas with PTFE stator

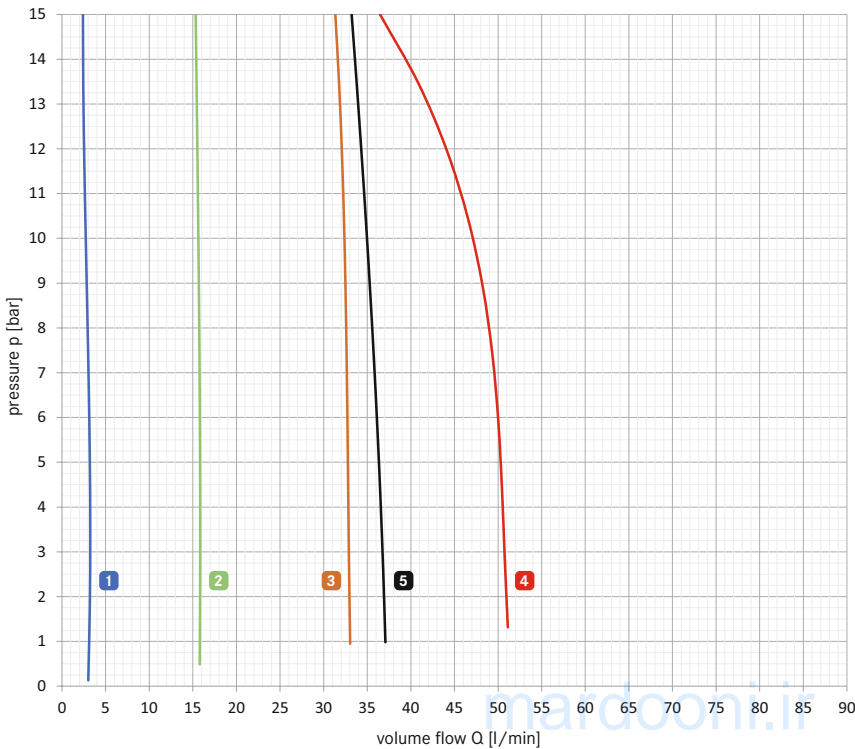

	rotor/stator geometry	rpm
1	R17	250
2	R17	1.000
3	R33	1.000
4	R52	1.000
5	R83	500

# Performance charts

Performance chart VISCOPOWER at 3.000 mPas with PTFE stator

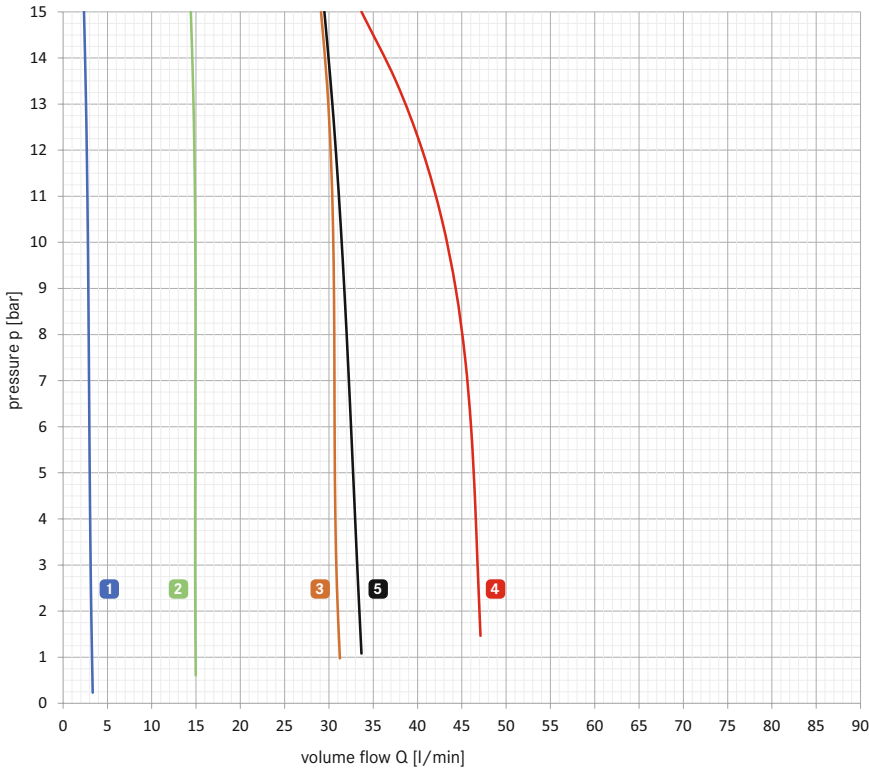

	rotor/stator geometry	rpm
1	R17	250
2	R17	1.000
3	R33	1.000
4	R52	1.000
5	R83	500

Performance chart VISCOPOWER at 10.000 mPas with PTFE stator

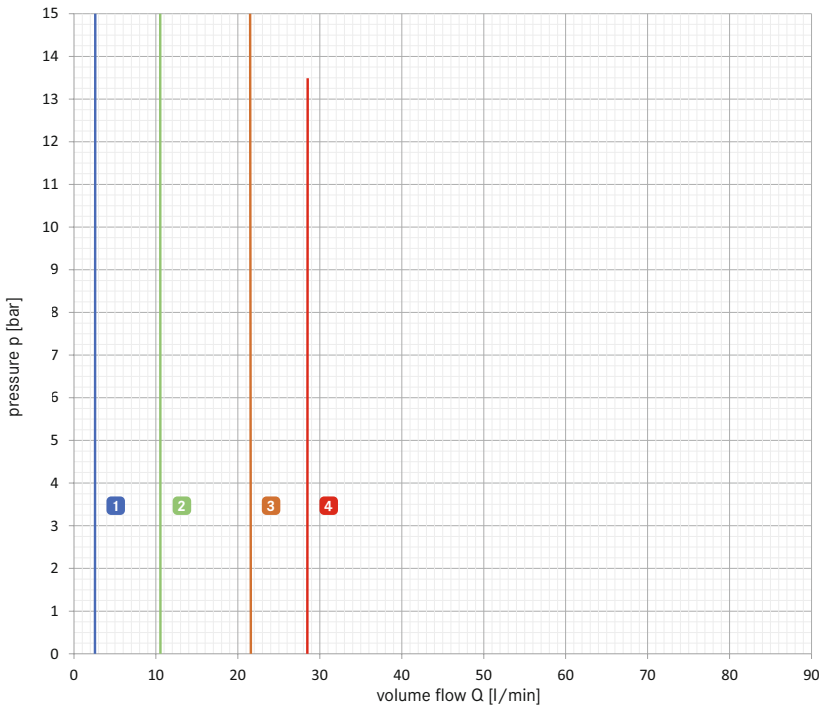

	rotor/stator geometry	rpm
1	R17	250
2	R17	1.000
3	R33	1.000
4	R52	1.000

mardooni. FLUX-GERÄTE GMBH

Talweg 12 · D-75433 Maulbronn  
 Tel +49 7043 101-0 · Fax +49 7043 101-444  
 info@flux-pumpen.de · www.flux-pumps.com