

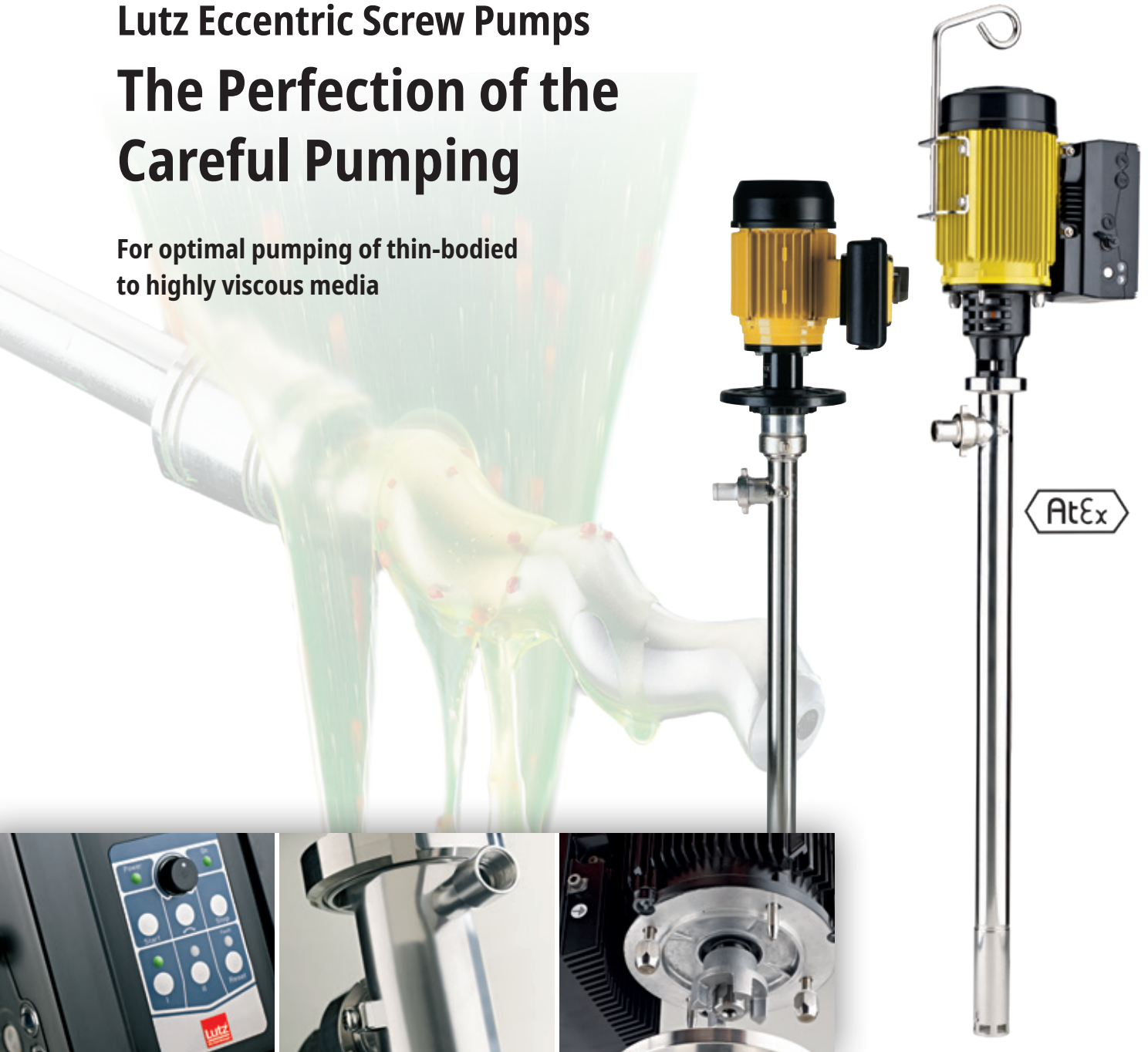

Lutz Eccentric Screw Pumps The Perfection of the Careful Pumping

For optimal pumping of thin-bodied
to highly viscous media



Safety is our Concern



Clean results that you can rely on

Lutz vertical eccentric screw pumps are suitable for pumping media ranging from aqueous through to highly viscous Newtonian and non-Newtonian media. The pumps are suitable for abrasive media and media containing solids, but also for neutral, aggressive and easily combustible liquids under high pumping pressure.

- **Variable flow rate**
- **Large pumping volume**
- **Self-priming**
- **Dynamic shaft seal**
- **Practically no shearing effect on the pump medium**
- **Gentle and practically pulsation-free pumping**
- **Variable drive concept**



Our expectation:

To meet standards and set benchmarks



Function:

- The eccentric screw rotates in an elastomer or solids stator.
- The rotation leads to chambers being formed in which the media are enclosed and carried forwards.
- Gentle low-pulsation pumping principle with little shearing effect.
- Thanks to the immersed vertical set-up in the container opening, the pump works in inlet operation and can be used immediately.
- There is no suction line, meaning that you don't have to worry about having to evacuate it in advance, and no loss in suction pressure.

Industries:

The pumps are used for a multitude of purposes in the chemistry and petrochemistry, paint and lacquer, food and beverage, and pharmaceuticals and cosmetics industries.



The Lutz Highlights

A clear plus when it comes to profitability and saving time

For many years, Lutz Eccentric Screw Pumps of series B70V have established themselves in pumping a wide range of media in all industrial sectors. With innovative new products and a holistic application-oriented solution concept, Lutz has once again expanded its range of eccentric screw pumps for pumping viscous media in terms of performance, flexibility and reliability.

The Lutz highlights and new developments prove their worth particularly when it comes to specific customer requests and changing application conditions.



Variable speed control

- Flow rate can be infinitely adjusted to the working conditions (viscosity, flowability)
- The pump and pumping line are easy to empty by reversing the rotating direction
- Custom parameterisation using free-of-charge PC software or a remote control
- The basic settings and presets can be set and selected conveniently (start/stop, pump or emptying mode)
- High flexibility for changing application conditions



Motor quick-action coupling and lifting device

- Enables the motor and pump tube to be connected and separated quickly.
- Simplifies inserting or removing the pump from the container.
- Provided as standard on the B70V-D and B70V-D Sanitary series

The Lutz Highlights

New benchmarks when it comes to tank drainage



The intelligent solution: B70V 75.1

- First eccentric screw drum pump with a up to flow rate of 75 l/min from a bunghole drum
- Special rotor/stator geometry with **50% greater flow rate** while maintaining the same dimensions

The new development: B70V 120.1

- For pumping highly viscous and pasty media, through to the flowability limit
- Safe product removal from bung-lid drums, IBC containers and stationary containers with a up to flow rate of 120 l/min
- Generously dimensioned pumping geometry enables low speed to protect the product
- Hollow rotor for improved smooth running while at the same time reducing weight

**Up to the challenge: B70V-HD
with circulation/flushing connection**

- For viscous, tacky, crystallizing, contaminated or thermosetting fluids such as paints and lacquers
- Constant rinse flow through the circulation/flushing connection prevents blockages and material deposits in the mechanical seal area
- Pump and pressure line can be emptied using the 3-phase reversible motor and rinsed with solvents
- Atex-approved

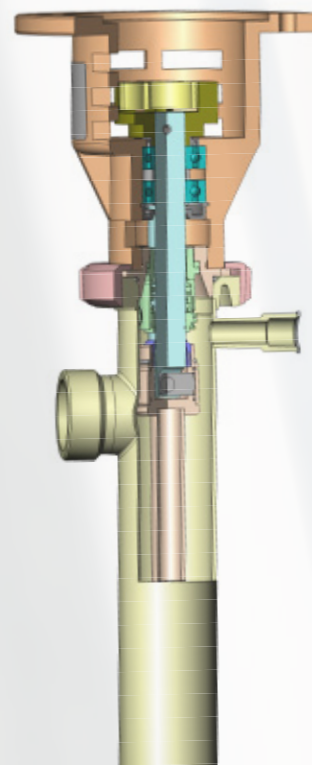

Lutz Eccentric Screw Pumps



- Flow measurement without direct contact with the medium – ideal for highly viscous, solid-containing and shear-sensitive media
- Also for hygienic, care-intensive applications in the food-, pharmaceutical- and cosmetics industry
- Easy evaluation and control with Lutz operating unit BE 10 with touchscreen display and plain text menu navigation (evaluating units and external control provided by the customer possible)
- Automatic filling of pre-selected quantities (batch function) with Lutz relay module RM10
- All live-/data elements on the motor-lifting device unit, pump tube can be detached by a quick-action coupling
- Pump tube without electronic parts – for a careful cleaning and disinfection, also by water jet or cleaning machine.

- ✓ High precision
- ✓ Contact-free
- ✓ Wear-free
- ✓ Hygienically designed
- ✓ Easy-to-clean
- ✓ Free from pressure loss
- ✓ Mobile and versatile



Lutz Eccentric Screw Pumps

SanitaryPlus and in PURE version

The new hygienic pump B70V SanitaryPlus sets new standards concerning an easy-to-clean design and is therefore at best suitable for the use in the food-, pharmaceutical- and cosmetics industry. An important feature of this pump is its one-piece joint-free drive shaft and the consistent thread-free design in the hydraulic area which allows hygienic and safe operating procedures.

Only very few components reduce assembly- and disassembly times as well as the cleaning effort considerably. The materials are in accordance with the applicable Regulations of FDA (Food and Drug Administration), USP (United States Pharmacopeia) and EC 1935/2004 and moreover the pump has an approval according to 3-A Sanitary Standard and ATEX.

Lutz offers with the PURE series food-safe products which are in conformity with the Regulations according to 1935/2004/EC and FDA.

All products feature a high surface quality, food-safe Tri-Clamp connections and a construction without grease filling.



- ✓ Hygienically designed according to the latest 3-A standards
- ✓ Gentle pumping of viscous and shear-sensitive media
- ✓ Easy to dismantle and easy to clean due to just a few components
- ✓ Thread-free, manually detachable quick connections
- ✓ Polished metal surface $R_a < 0,8$
- ✓ For liquid foodstuffs and luxury foodstuffs, pharmaceutical substances and cosmetic products

NEW



- ✓ Gentle pumping of viscous and shear-sensitive media
- ✓ Physiologically safe type
- ✓ High surface quality
- ✓ Food-safe connections
- ✓ Also for alcoholic food products, cosmetics and pharmaceuticals and flammable cleaning products



Lutz Eccentric Screw Pumps

Series B70V



Strength in tranquillity

Lutz Eccentric Screw Pumps are absolute specialists when it comes to pumping media gently. They sustain low amounts of wear, are robust and operationally safe, and are easy to dismantle and clean.

Light and mobile:

Lutz HD-E

A tactically clever development: The HD-E simply conveys the benefits of the drum pump for thinbodied fluids to the semi-viscous range – in fact even tailored to the specific requirements. Not only is this pump convincing in terms of power, it is also very easy to handle. The other benefits are quite obvious as well: The HD-E features an outer tube that is easy to detach, a bearing head with a mechanical seal and a freewheeling shaft with an eccentric screw gear acting as pumping element – all of which is easy to detach and to clean. The delivery rate amounts up to 20 l/min. with a delivery head of up to 4 bar. Drive: 230 V AC voltage.

Taking the right turn

A strong team for demanding tasks



Oil-free

for pharmaceutical,
food & cosmetics
industry



FDA



Oil-free

for pharmaceutical,
food & cosmetics
industry



FDA

NEW

Easy and mobile pumping of viscous liquids: **Lutz HD-E-SR**

Viscous liquids are used in a wide range of production processes. For this purpose, they are transferred and filled from different containers.

In practise, smaller and narrow-necked containers with different bunghole sizes are increasingly being used for transferring viscous liquids which require a smaller pipe diameter.

With the new HD-E-SR eccentric screw pump, with a max. outer tube diameter of 41 mm, liquids up to 30,000 mPas can be pumped.

With a compressed air motor or 230 V AC motor, the pump weighs only between 5.5 and 11 kg and meets the customer's requirements for easy and handy operation. The flow rate is up to 17 l/min, delivery head up to 6 bar.

Light and convenient: **Lutz B70V-SR**

This convenient and powerful pump will take you „through thick and thin“. It covers an enormous range: The B70 V-SR is suitable for aqueous to highly-viscous substances with or without fibrous or solid matters. The pump is either air operated or with 230 V AC voltage (different voltages and frequencies on request), which makes it the ideal partner, even in mobile applications. The delivery rate amounts up to 50 l/min. with a delivery head of up to 8 bar.

Lutz Eccentric Screw Pumps

Series B70V



Robust and versatile:

Lutz B70V-D

A powerful pump that is an ideal match for semiviscous or even highly viscous, tough substances right up to their flowability limits (to 100,000 mPas). Another benefit: The B70V-D has a capacity of up to 75 l/min with a delivery head of up to 10 bar. The power transmission from the motor to the eccentric screw gear is implemented through a torsion shaft or a universal joint shaft. You can choose between air operation or 400 V three-phase.

Gentle, reliable and hygienic:

Lutz B70V SanitaryPlus

Approved according to the 3-A Sanitary Standard, the pump has been designed according to the latest directives for the high demands in the food, pharmaceuticals and cosmetics industry. The new design provides a high level of machining on all liquid contact surfaces and ensures reliability with low maintenance and full manual cleaning. The pump can be dismantled simply; the drive motor can be separated from the pump tube instantly thanks to the new quick-action coupling. With a flow rate of 12 to 75 l/min. and an operating pressure of up to 10 bar, the Lutz B70V SanitaryPlus is optimally suitable for pumping thin-bodied to highly viscous media gently.

You will find more information in our separate leaflet: **Certified solutions for the food, pharmaceutical and cosmetics Industry** (Art.-Nr. 0699-315)

Taking the right turn

A strong team for demanding tasks



Up to the challenge: **Lutz B70V-HD**

Developed for special requirements, and suitable with viscous, tacky, crystallizing, contaminated or thermosetting fluids such as paints and lacquers. The constant rinse flow through the circulation/flushing connection prevents blockages and material deposits in the mechanical seal area. The pump can be cleaned simply and is ATEX-approved. Driven by 3-phase/compressed air motors (B70V-HD-D, DA) or universal motors (B70V-HD-SR).

Our top performer: **Lutz B70V 120.1**

When you're in the thick of it: for pumping highly viscous and pasty media through to the flowability limit with a flow rate of 120 l/min. It is driven by speed-reduced 3-phase current motors. A robust, independent lantern mounted on roller bearings with torsionally flexible claw-type coupling ensures secure power transmission from the IEC drive motors to the pump hydraulics. The pump can also be easily dismantled thanks to tri-clamp connections.

Lutz Eccentric Screw Pumps

Lutz HD-E

Product detail	Pump tube	HD-E	
	Category 1 / 2 (acc. to ATEX)	no	
	Immersion tube diameter:	up to mm	41
	Temperature of medium:	up to °C	100
	Material:	Pump tube	Stainless steel (1.4571)
		Stator	PTFE
	Pressure joint:	Outer thread	G 1 1/4
	Weight:	kg	3.5
	Length: 1000 mm *	Order-No.	0155-010

*The length complies approx. to dimension C in the dimension table. Special lengths 600–1500 mm on request

Choice of motors	Operating data				
	Single phase motor				
	Output	0.55 KW	Delivery rate	up to l/min.	20
	Voltage	230 V	Delivery head	up to bar	4
	Speed	1500 1/min.	Viscosity	mPas	500-4000
	Protection type:	IP 54	Weight (kg)		11.9
	Order-No.	0155-032			

for viscosities from 500 to 4000 mPas

Materials (coming into contact with the pumped medium)

Version:	HD-E
Pump tube:	Stainless steel (1.4571)
Stator:	PTFE
Mechanical seal:	Carbon/SIC (Bellows constr.)
Secondary seal:	FPM
Drive shaft:	Stainless steel (1.4571)



Pump tube also available in PURE version with Tri-Clamp connection. You will find more information in our leaflet: Certified solutions for the food, pharmaceutical and cosmetics Industry (Order-No. 0699-315)

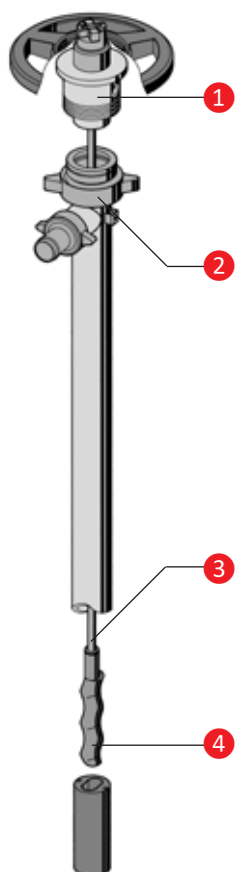

1 Bearing head with mechanical seal

- Compact unit for bearing and bearing shaft
- Wide range of mechanical seals

2 Easy detachable pump tube

- Easy cleaning
- No tools for disassembling of pump

3 Free running drive shaft

- Easy to clean

4 Rotor

- Smooth pumping of liquids
- High pressure
- Constant volumetric flow

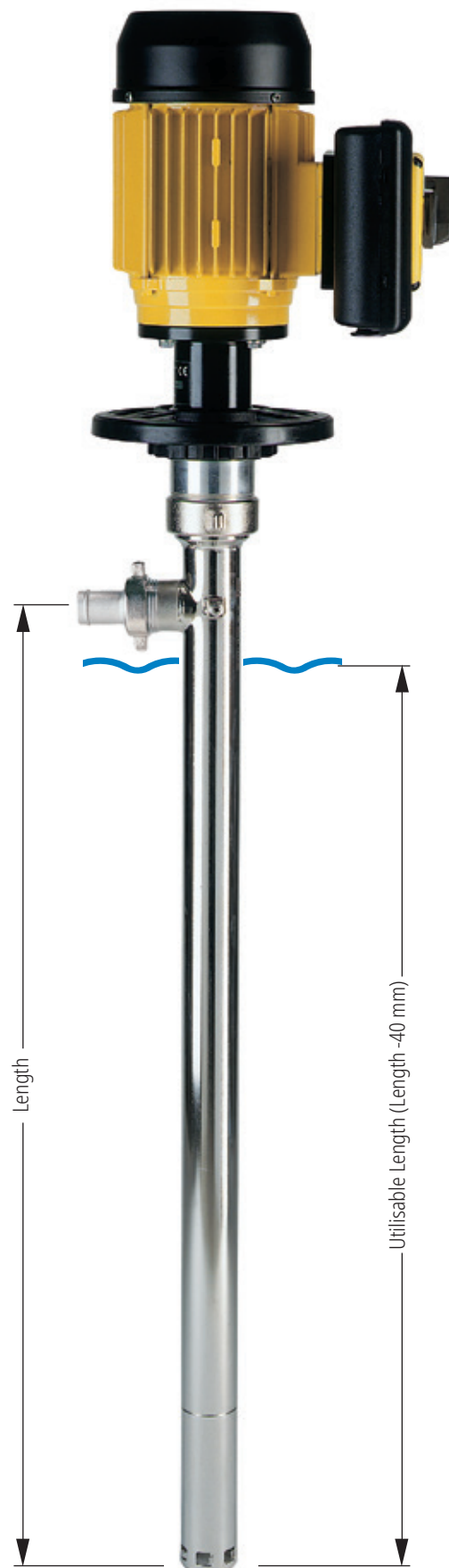

Lutz Eccentric Screw Pumps

Lutz HD-E-SR

Product detail	Pump tube	HD-E-SR	
	Category 1 / 2 (acc. to ATEX)	no	
	Immersion tube diameter:	max. mm	41
	Delivery rate:	up to l/min.	17
	Delivery head:	up to bar	6
	Temperature of medium:	up to °C	100
	Material:	Pump tube	Stainless steel (1.4571)
		Stator	PTFE
	Pressure joint:	Outer thread	G 1 1/4
	Weight:	kg	4.5
	Length: 1000 mm *	Order-No.	0155-012

* The length complies approx. to dimension C in the dimension table. Special length 600 - 1500 mm on request.

Choice of motors

	Universal motors non-ex. proof	MI 4	MI 4-E	MA II 3	MA II 5	MA II 7
	Type	500 W, 230 V	500 W, 230 V	460 W, 230 V	575 W, 230 V	795 W, 230 V
	Protection type/Weight	IP 24 2.8 kg	IP 24 2.8 kg	IP 54 4.6 kg	IP 54 5.4 kg	IP 54 6.6 kg
	Speed controller	no	yes			
	Order-No. (without low-voltage release)	0030-000	0030-001	0060-000	0060-001	0060-002
	Order-No. (with low-voltage release)	-	-	0060-008	0060-009	0060-010

	Compressed air motors	MD1xL	MD2xL
	Type	1000 W	1000 W
	Operating pressure	6 bar	6 bar
	Weight	1.0 kg	1.4 kg
	Order-No.	0004-725	0004-735

Different voltages and frequencies on request.
For sticky and hardening liquids please contact our Lutz head office to select the suitable pump.

for viscosities from 500 to 30.000 mPas

Materials (coming into contact with the pumped medium)

Version:	HD-E-SR
Pump tube:	Stainless steel (1.4571)
Stator:	PTFE
Mechanical seal:	Carbon/SiC (Bellows constr.)
Secondary seal:	FPM
Drive shaft:	Stainless steel (1.4571)





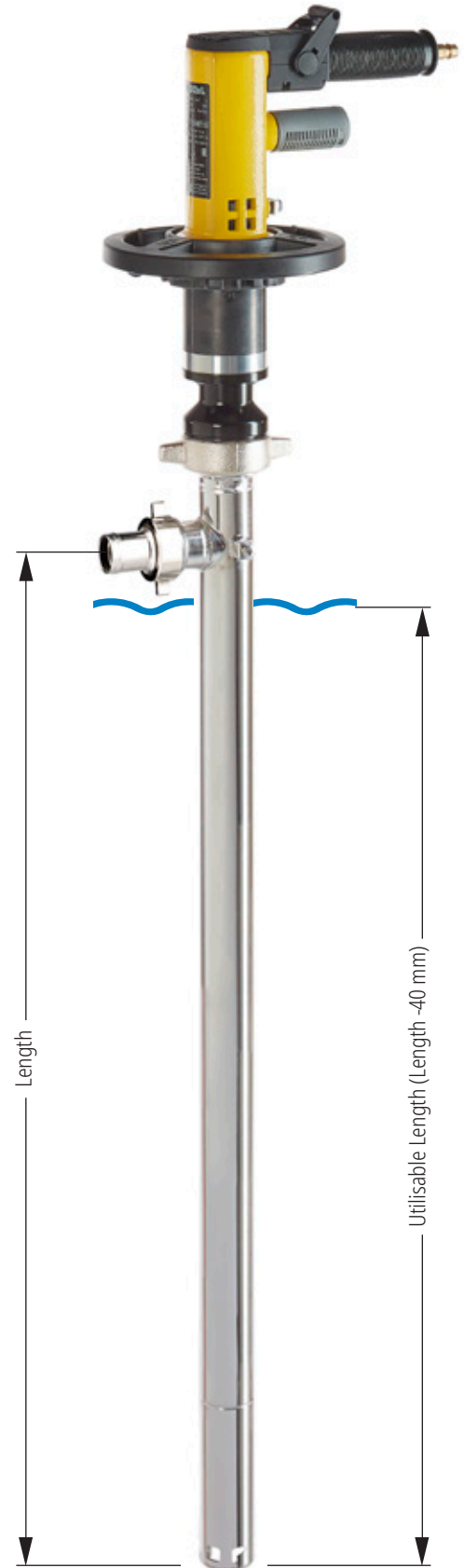
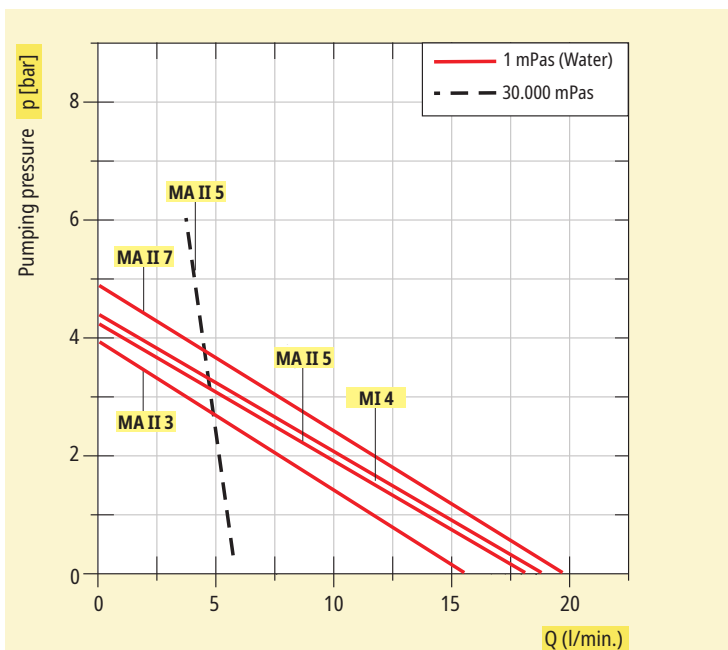
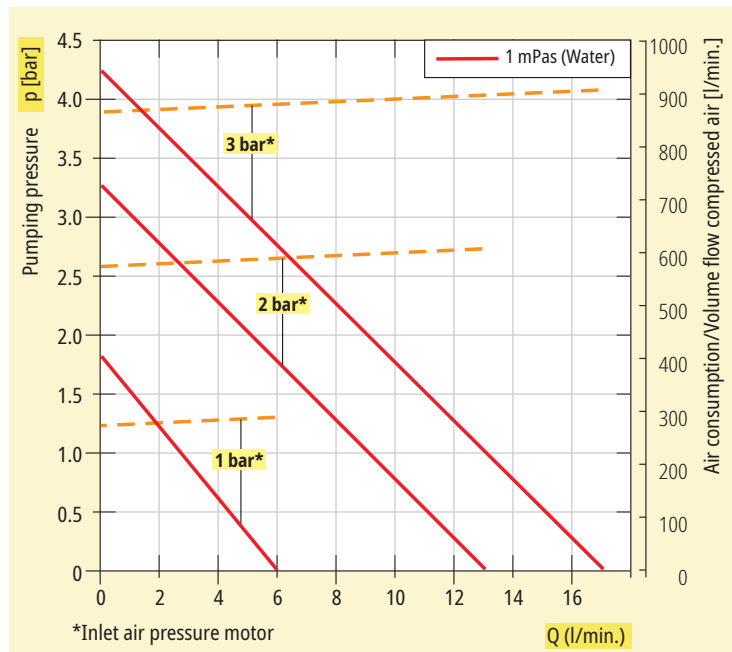

Pump tube also available in PURE version with Tri-Clamp connection. You will find more information in our leaflet: Certified solutions for the food, pharmaceutical and cosmetics Industry (Order-No. 0699-315)



Lutz Eccentric Screw Pumps

B70V-SR and B70V HD-SR 12.1 and 25.1

Product detail			Pump tube						B70V-SR			
	Size		12.1	12.1	12.1	25.1	25.1	25.1				
	Seal	Packing gland (St)	MS	MS	St	MS	MS	St				
		Mechanical seal (MS)										
	Drive shaft	Torsion shaft (TS)	TS	UJ	UJ	TS	UJ	UJ				
		Universal joint shaft (UJ)										
	Delivery rate*	up to l/min.	12	12	12	25	25	25				
	Delivery head*	up to bar	6	6	6	8	8	8				
	Temp. of medium**	up to °C	140	140	140	140	140	140				
	Material outer tube		1.4571/1.4404	1.4571/1.4404	1.4571/1.4404	1.4571/1.4404	1.4571/1.4404	1.4571/1.4404				
	Immersion tube diameter	mm	54	54	54	54	54	54				
	Pressure joint	Outer thread	G 1 1/2	G 1 1/2	G 1 1/2	G 1 1/2	G 1 1/2	G 1 1/2				
	Weight	kg	7	7	7	7	7	7				
	Length***	mm	1000	1000	1000	1000	1000	1000				
	Stator NBR light (T max. 80 °C)	Order-No.	-	-	-	0174-131	0174-141	0174-121				
Stator FPM (T max. 140 °C)	Order-No.	-	-	-	0174-132	0174-142	0174-122					
Stator PTFE (T max. 140 °C)	Order-No.	0174-014	0174-024	0174-004	0174-134	0174-144	0174-124					
B70V HD-SR Stator PTFE (T max. 100 °C)	Order-No.		0174-026			0174-146						
<p>* Determined with water at 20 °C, three-phase motor (900 rpm) and elastomer stator ** with PTFE Stator (the medium temperature of explosion proof eccentric screw pumps B70 may not exceed 100°C) *** The length complies approx. to dimension C in the dimension table. Special length 500 - 2000 mm on request (version with joint shaft only)</p>												
<p>● Explosion proof eccentric screw pump approved category 1 / 2 (acc. to ATEX) for pumping inflammable liquids of the explosion group IIA (B70V-SR) or IIB (B70V HD-SR) and temperature class T4</p>												
Choice of motors												
	Universal motors non-ex. proof		MI 4	MI 4-E	MA II 3	MA II 5	MA II 7					
	Type		500 W, 230 V	500 W, 230 V	460 W, 230 V	575 W, 230 V	795 W, 230 V					
	Protection type/Weight		IP 24 2.8 kg	IP 24 2.8 kg	IP 54 4.6 kg	IP 54 5.4 kg	IP 54 6.6 kg					
	Speed controller		no	yes								
	Order-No. (without low-voltage release)		0030-000	0030-001	0060-000	0060-001	0060-002					
Order-No. (with low-voltage release)		-	-	0060-008	0060-009	0060-010						
	Universal motors explosion proof		ME II 3	ME II 5	ME II 7	ME II 8						
	Type		460 W, 230 V	580 W, 230 V	795 W, 230 V	930 W, 230 V						
	Protection type/Weight		IP 54 5.5 kg	IP 54 6.3 kg	IP 54 7.5 kg	IP 54 8 kg						
	Order-No. (with low-voltage release)		0050-000	0050-001	0050-002	0050-042						
	Order-No. (without low-voltage release)		0050-016	0050-017	0050-018	0050-041						
	Compressed air motors		MD1xL			MD2xL						
	Type		1000 W			1000 W						
	Operating pressure		6 bar			6 bar						
	Weight		1.0 kg			1.4 kg						
	Order-No.		0004-725			0004-735						

Different voltages and frequencies on request.
 For sticky and hardening liquids please contact our Lutz head office to select the suitable pump.

B70V-SR and B70V HD-SR 12.1 and 25.1

for viscosities from 1 - 100,000 mPas (Compressed air motors)
1 - 30,000 mPas (Universal motors)

Materials (coming into contact with the pumped medium):

Version:	B70V-SR 12.1/25.1	B70V HD-SR 12.1/25.1
Housing:	Stainless steel (1.4571/1.4404)	Stainless steel (1.4571/1.4404)
Rotor:	Stainless steel (1.4571)	Stainless steel (1.4571)
Seals:	FPM	FPM
Mechanical seal:	Carbon/CrMo-casting, FPM	WC/WC/FPM
Packing gland:	PTFE Soft packing safe for use with foodstuffs	-
Drive shaft:	Stainless steel (1.4571)	Stainless steel (1.4571)
Stator material:	NBR light, FPM, PTFE	PTFE



Pump tube with PTFE stator, also available in PURE version with Tri-Clamp-connection. You will find more information in our leaflet: Certified solutions for the food, pharmaceutical and cosmetics Industry (Order-No. 0699-315)

Important Information!

When pumping in „Zone 0“ areas or pumping flammable liquids only pumps with mechanical seal, universal joint shaft and PTFE stator are approved.

Viscosity range from aqueous to fluidity range.
Medium table with liquid examples see chemical resistance table.

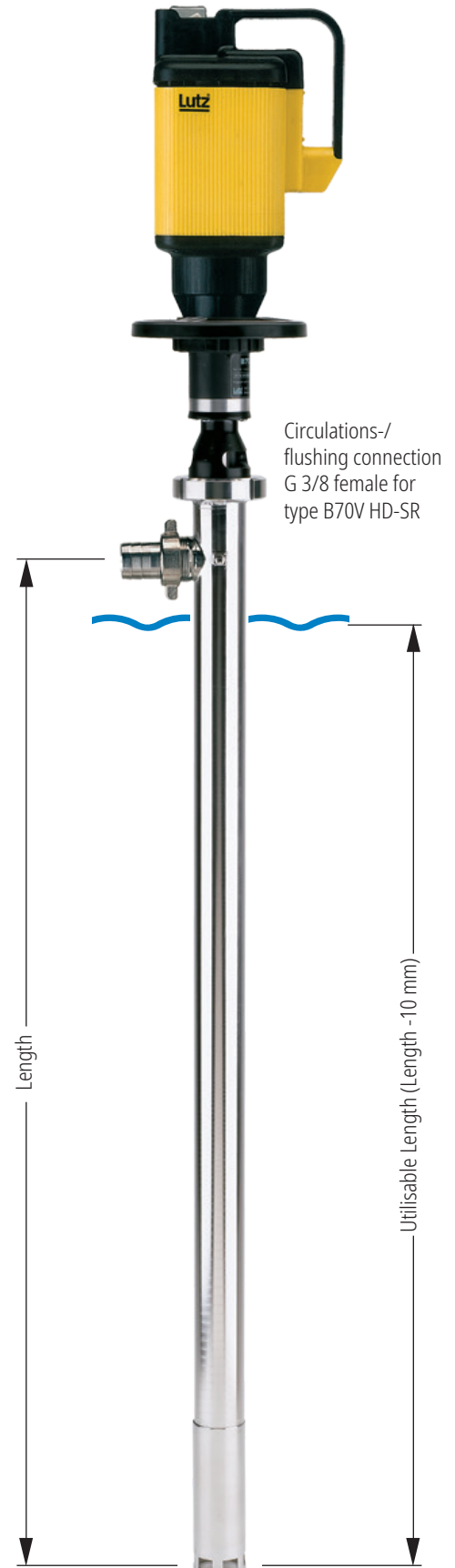
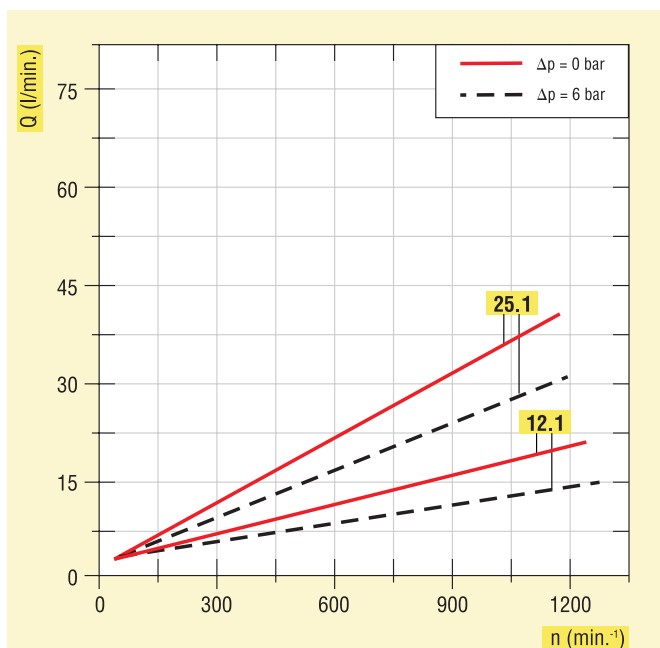

Lutz Eccentric Screw Pumps

Product detail



Pump tube		B70V-SR		
Size		50.1	50.1	50.1
Seal	Packing gland (St)	MS	MS	St
	Mechanical seal (MS)			
Drive shaft	Torsion shaft (TS)	TS	UJ	UJ
	Universal joint shaft (UJ)			
Delivery rate*	up to l/min.	50	50	50
Delivery head*	up to bar	8	8	8
Temp. of medium**	up to °C	140	140	140
Material outer tube		1.4571/1.4404	1.4571/1.4404	1.4571/1.4404
Immersion tube diameter	mm	54	54	54
Pressure joint	Outer thread	G 1 1/2	G 1 1/2	G 1 1/2
Weight	kg	7	7	7
Length***	mm	1100	1100	1100
Stator NBR light (T max. 80 °C)	Order-No.	0174-511	0174-521	0174-501
Stator FPM (T max. 140 °C)	Order-No.	0174-512	0174-522	0174-502
Stator PTFE (T max. 140 °C)	Order-No.	0174-514	0174-524	0174-504
B70V HD-SR Stator PTFE (T max. 100 °C)	Order-No.		0174-526	

* Determined with water at 20 °C, three-phase motor (900 rpm) and elastomer stator
 ** with PTFE Stator (the medium temperature of explosion proof eccentric screw pumps B70 may not exceed 100°C)
 *** The length complies approx. to dimension C in the dimension table. Special length 500 - 2000 mm on request (version with joint shaft only)



● Explosion proof eccentric screw pump approved category 1 / 2 (acc. to ATEX) for pumping inflammable liquids of the explosion group IIA (B70V-SR) or IIB (B70V HD-SR) and temperature class T4

Choice of motors



Universal motors non-ex. proof	MI 4	MI 4-E	MA II 3	MA II 5	MA II 7
Type	500 W, 230 V	500 W, 230 V	460 W, 230 V	575 W, 230 V	795 W, 230 V
Protection type/Weight	IP 24 2.8 kg	IP 24 2.8 kg	IP 54 4.6 kg	IP 54 5.4 kg	IP 54 6.6 kg
Speed controller	no	yes			
Order-No. (without low-voltage release)	0030-000	0030-001	0060-000	0060-001	0060-002
Order-No. (with low-voltage release)	-	-	0060-008	0060-009	0060-010



Universal motors explosion proof	ME II 3	ME II 5	ME II 7	ME II 8
Type	460 W, 230 V	580 W, 230 V	795 W, 230 V	930 W, 230 V
Protection type/Weight	IP 54 5.5 kg	IP 54 6.3 kg	IP 54 7.5 kg	IP 54 8 kg
Order-No. (with low-voltage release)	0050-000	0050-001	0050-002	0050-042
Order-No. (without low-voltage release)	0050-016	0050-017	0050-018	0050-041



Compressed air motors	MD1xL	MD2xL
Type	1000 W	1000 W
Operating pressure	6 bar	6 bar
Weight	1.0 kg	1.4 kg
Order-No.	0004-725	0004-735

Different voltages and frequencies on request.
 For sticky and hardening liquids please contact our Lutz head office to select the suitable pump.

B70V-SR and B70V HD-SR 50.1

for viscosities from 1 - 100,000 mPas (Compressed air motors)
1 - 20,000 mPas (Universal motors)

Materials (coming into contact with the pumped medium):

Version:	B70V-SR 50.1	B70V HD-SR 50.1
Housing:	Stainless steel (1.4571/1.4404)	Stainless steel (1.4571/1.4404)
Rotor:	Stainless steel (1.4571)	Stainless steel (1.4571)
Seals:	FPM	FPM
Mechanical seal:	Carbon/CrMo-casting, FPM	WC/WC/FPM
Packing gland:	PTFE Soft packing safe for use with foodstuffs	-
Drive shaft:	Stainless steel (1.4571)	Stainless steel (1.4571)
Stator material:	NBR light, FPM, PTFE	PTFE



Pump tube with PTFE stator, also available in PURE version with Tri-Clamp-connection. You will find more information in our leaflet: Certified solutions for the food, pharmaceutical and cosmetics Industry (Order-No. 0699-315)

Important Information!

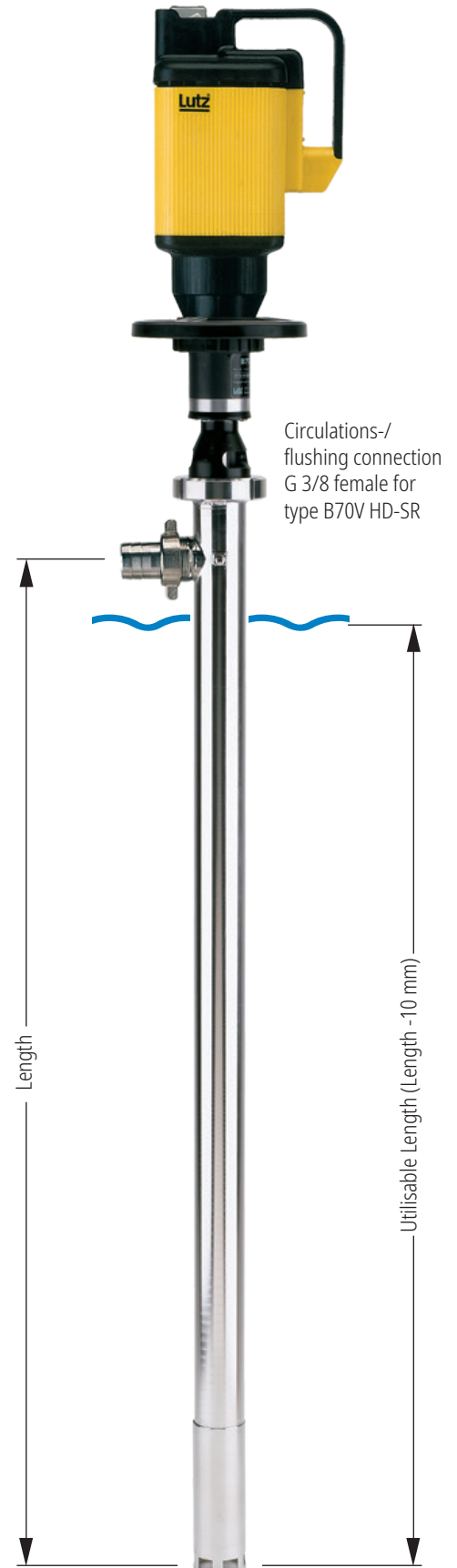
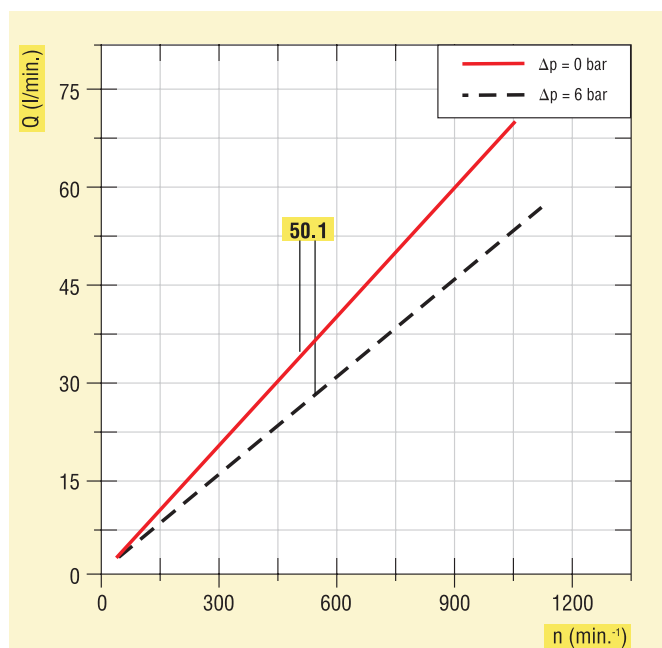

When pumping in „Zone 0“ areas or pumping flammable liquids only pumps with mechanical seal, universal joint shaft and PTFE stator are approved.

Viscosity range from aqueous to fluidity range.
Medium table with liquid examples see chemical resistance table.



Lutz Eccentric Screw Pumps

B70V 12.1 and 25.1

Product detail			Pump tube						B70V	
	Size		12.1	12.1	12.1	25.1	25.1	25.1	25.1 Steel	
	Seal	Packing gland (St)	MS	MS	St	MS	MS	St	MS	
		Mechanical seal (MS)								
	Drive shaft	Torsion shaft (TS)	TS	UJ	UJ	TS	UJ	UJ	TS	
		Universal joint shaft (UJ)								
	Delivery rate*	up to l/min.	12	12	12	25	25	25	25	
	Delivery head*	up to bar	6	6	6	8	8	8	8	
	Temp. of medium**	up to °C	140	140	140	140	140	140	80	
	Material outer tube		1.4571/1.4404	1.4571/1.4404	1.4571/1.4404	1.4571/1.4404	1.4571/1.4404	1.4571/1.4404	Galv. Steel	
	Immersion tube diameter	mm	54	54	54	54	54	54	54	
	Pressure joint	Outer thread	G 1 1/2	G 1 1/2	G 1 1/2	G 1 1/2	G 1 1/2	G 1 1/2	G 1 1/2	
	Weight	kg	7	7	7	7	7	7	7	
	Length***	mm	1000	1000	1000	1000	1000	1000	1000	
	Stator NBR light (T max. 80 °C)	Order-No.	-	-	-	0172-121	0173-131	0173-121	0171-121	
Stator FPM (T max. 140 °C)	Order-No.	-	-	-	0172-122	0173-132	0173-122	0171-122		
Stator PTFE (T max. 140 °C)	Order-No.	0172-004	0173-014	0173-004	0172-124	0173-134	0173-124	0171-124		
B70V HD-D Stator PTFE (T max. 100 °C)	Order-No.		0173-016			0173-136				
<p>* Determined with water at 20 °C, three-phase motor (900 rpm) and elastomer stator Combination of packing gland and torsion shaft on request</p> <p>** with PTFE Stator (the medium temperature of explosion proof eccentric screw pumps B70 may not exceed 100°C)</p> <p>*** The length complies approx. to dimension C in the dimension table. Special length 500 - 2000 mm on request (version with joint shaft only)</p>										
<p>● Explosion proof eccentric screw pump approved category 1 / 2 (acc. to ATEX) for pumping inflammable liquids of the explosion group IIA (B70V-SR) or IIB (B70V HD-SR) and temperature class T4</p>										
Motor selection										
	Motors with cable terminal box		For B70V - 12.1 and B70V - 25.1							
	Version		0.75 kW, 900 1/min.		1.1 kW, 700 1/min.		1.1 kW, 900 1/min.			
	Protection type/weight		IP 55 22 kg		IP 55 22 kg		IP 55 34 kg			
	Order No.		0172-901		0172+826		0172-903			
	Motors with protection switch		For B70V - 12.1 and B70V - 25.1							
	Version		0.75 kW, 900 1/min.		1.1 kW, 700 1/min.		1.1 kW, 900 1/min.			
	Protection type/weight		IP 55 22 kg		IP 55 22 kg		IP 55 34 kg			
	Order No.		0172-900		0172+825		0172-902			
	Motors, explosion proof		For B70V - 12.1 and B70V - 25.1							
	Version		0.55 kW, 900 1/min.		0.95 kW, 900 1/min.					
Protection class		II 2 G Ex e II T3		II 2 G Ex e II T3						
Protection type/weight		IP 55 17 kg		IP 55 23 kg						
Order No.		0172-804		0172-816						
Motors with frequency converter		For B70V - 12.1 and B70V - 25.1								
Version		0.75 kW, 0-900 1/min.		1.5 kW, 180-900 1/min.						
Protection type/weight		IP 55 22 kg		IP 55 35 kg						
Order No.		0172-768		0172-913						
	Compressed air motor		For B70V - 12.1 and B70V - 25.1							
	Version		4 DA , 0.45 kW, 900 1/min., Weight 5 kg, Operating pressure: at 6 bar, Air consumption 55 Nm ³ /h, 87 db (A)				6 DA , 1.0 kW, 900 1/min., Weight 14 kg, Operating pressure: at 6 bar, Air consumption 80 Nm ³ /h, 87 db (A)			
	Air connection thread		G 3/8				G 1/2			
	Order No.		0172-821				0172-822			
Compressed air motors with muffler, max. operating pressure 7 bar, recommended speed (200 - 900 1/min.)										



B70V 12.1 and 25.1

for viscosities from 1 - 100,000 mPas

Materials (coming into contact with the pumped medium):

Version:	B70V 12.1/25.1	B70V 25.1 Steel	B70V HD 12.1/25.1
Housing:	SS (1.4571/1.4404)	galvanized steel	SS (1.4571/1.4404)
Rotor:	SS (1.4571)	soft-nitrided steel	SS (1.4571)
Seals:	FPM	FPM	FPM
Mechanical seal:	Carbon/CrMo-casting, FPM optional SiC/SiC, FPM	Carbon/CrMo-casting, FPM optional SiC/SiC, FPM	WC/WC/FPM
Packing gland:	PTFE Soft packing safe for use with food-stuffs	-	-
Drive shaft:	SS (1.4571)	galvanized steel	SS (1.4571)
Stator material:	NBR light, FPM, PTFE	NBR light, FPM, PTFE	PTFE



Pump tube with PTFE stator, also available in PURE version with Tri-Clamp-connection. You will find more information in our leaflet: Certified solutions for the food, pharmaceutical and cosmetics Industry (Order-No. 0699-315)

Important Information!

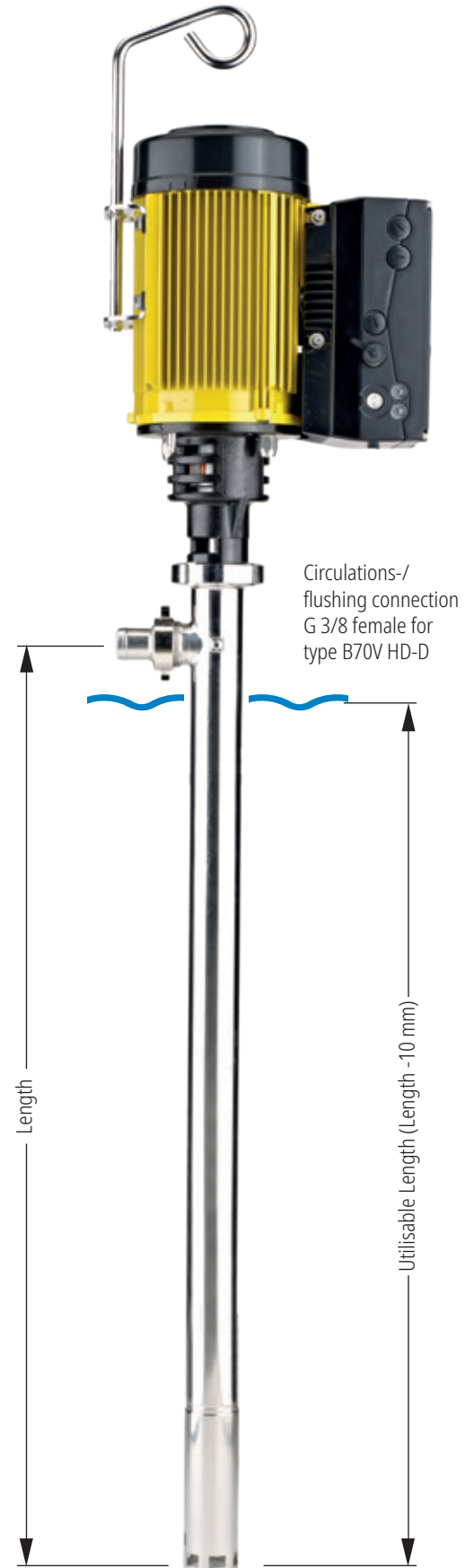
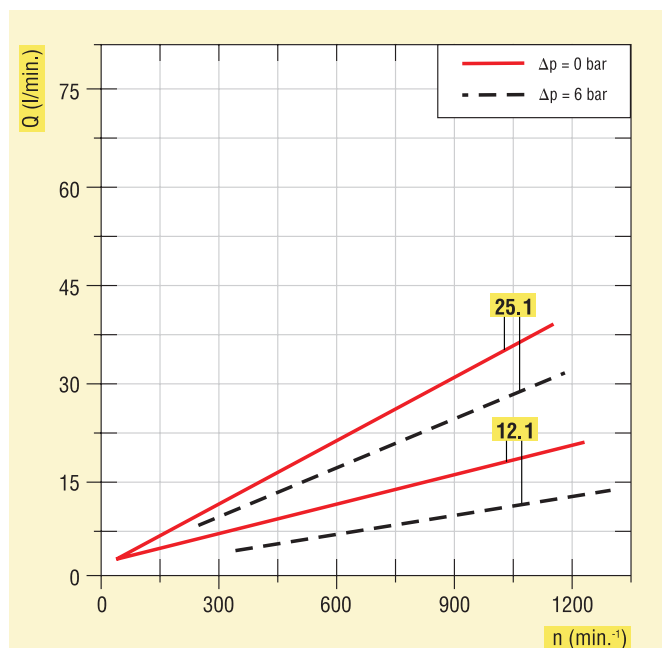

When pumping in „Zone 0“ areas or pumping flammable liquids only pumps with mechanical seal, universal joint shaft and PTFE stator are approved.

Viscosity range from aqueous to fluidity range.
Medium table with liquid examples see chemical resistance table.



Lutz Eccentric Screw Pumps

B70V 25.2 and 50.1

Product detail			Pump tube						B70V		
	Size		25.2	25.2	25.2	50.1	50.1	50.1			
	Seal	Packing gland (St)	MS	MS	St	MS	MS	St			
		Mechanical seal (MS)									
	Drive shaft	Torsion shaft (TS)	TS	UJ	UJ	TS	UJ	UJ			
		Universal joint shaft (UJ)									
	Delivery rate*	up to l/min.	25	25	25	50	50	50			
	Delivery head*	up to bar	10	10	10	8	8	8			
	Temp. of medium**	up to °C	140	140	140	140	140	140			
	Material outer tube		1.4571/1.4404	1.4571/1.4404	1.4571/1.4404	1.4571/1.4404	1.4571/1.4404	1.4571/1.4404			
	Immersion tube diameter	mm	54	54	54	54	54	54			
	Pressure joint	Outer thread	G 1 1/2	G 1 1/2	G 1 1/2	G 1 1/2	G 1 1/2	G 1 1/2			
	Weight	kg	7	7	7	7	7	7			
	Length***	mm	1100	1100	1100	1100	1100	1100			
	Stator NBR light (T max. 80 °C)	Order-No.	-	-	-	0172-501	0173-511	0173-501			
	Stator FPM (T max. 140 °C)	Order-No.	-	-	-	0172-502	0173-512	0173-502			
Stator PTFE (T max. 140 °C)	Order-No.	0172-254	0173-264	0173-254	0172-504	0173-514	0173-504				
B70V HD-D Stator PTFE (T max. 100 °C)	Order-No.		0173-266			0173-516					
<p>* Determined with water at 20 °C, three-phase motor (900 rpm) and elastomer stator ** with PTFE Stator (the medium temperature of explosion proof eccentric screw pumps B70 may not exceed 100°C) *** The length complies approx. to dimension C in the dimension table. Special length 500 - 2000 mm on request (version with joint shaft only)</p>											
<p>● Explosion proof eccentric screw pump approved category 1 / 2 (acc. to ATEX) for pumping inflammable liquids of the explosion group IIA (B70V-SR) or IIB (B70V HD-SR) and temperature class T4</p>											
Motor selection											
	Motors with cable terminal box		For B70V - 25.2 and B70V - 50.1								
	Version		1.1 kW, 700 1/min.			1.1 kW, 900 1/min.					
	Protection type/weight		IP 55 22 kg			IP 55 34 kg					
	Order No.		0172+826			0172-903					
	Motors with protection switch		For B70V - 25.2 and B70V - 50.1								
	Version		1,1 kW, 700 1/min.			1,1 kW, 900 1/min.					
	Protection type/weight		IP 55 22 kg			IP 55 34 kg					
	Order No.		0172+825			0172-902					
	Motors, explosion proof		For B70V - 25.2 and B70V - 50.1								
	Version		0,95 kW, 900 1/min.								
Protection class		II 2 G Ex e II T3									
Protection type/weight		IP 55 23 kg									
Order No.		0172-816									
Motors with frequency converter		For B70V - 25.2 and B70V - 50.1									
Version		0,75 kW, 0-900 1/min.			1,5 kW, 180-900 1/min.						
Protection type/weight		IP 55 22 kg			IP 55 35 kg						
Order No.		0172-768			0172-913						
	Compressed air motor		For B70V - 25.2 and B70V - 50.1								
	Version		8 DA , 1.7 kW, 900 1/min., Weight 18 kg, Operating pressure: at 6 bar, Air consumption 130 Nm ³ /h, 102 db (A)								
	Air connection thread		G 1/2								
	Order No.		0172-823								
	Compressed air motors with muffler, max. operating pressure 7 bar, recommended speed (200 - 900 1/min.)										



B70V 25.2 and 50.1

for viscosities from 1 - 100,000 mPas

Materials (coming into contact with the pumped medium):

Version:	B70V 25.2/50.1	B70V HD-D 25.2/50.1
Housing:	Stainless steel (1.4571/1.4404)	Stainless steel (1.4571/1.4404)
Rotor:	Stainless steel (1.4571)	Stainless steel (1.4571)
Seals:	FPM	FPM
Mechanical seal:	Carbon/CrMo-casting, FPM	WC/WC/FPM
Packing gland:	PTFE Soft packing safe for use with foodstuffs	-
Drive shaft:	Stainless steel (1.4571)	Stainless steel (1.4571)
Stator material:	NBR light, FPM, PTFE	PTFE



Pump tube with PTFE stator, also available in PURE version with Tri-Clamp-connection. You will find more information in our leaflet: Certified solutions for the food, pharmaceutical and cosmetics Industry (Order-No. 0699-315)

Important Information!



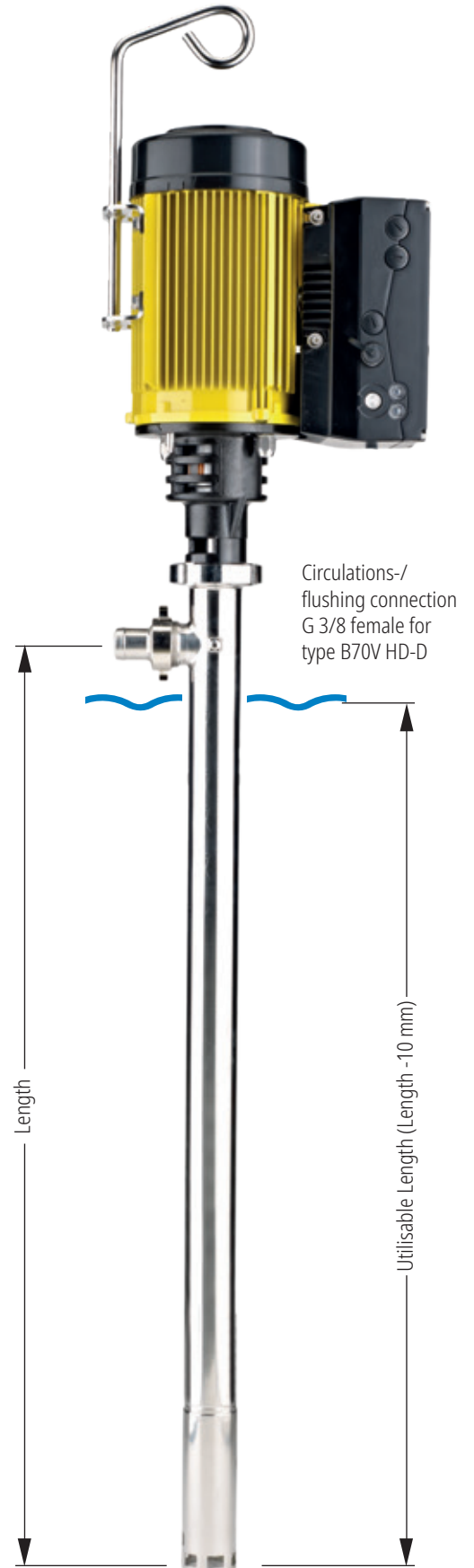
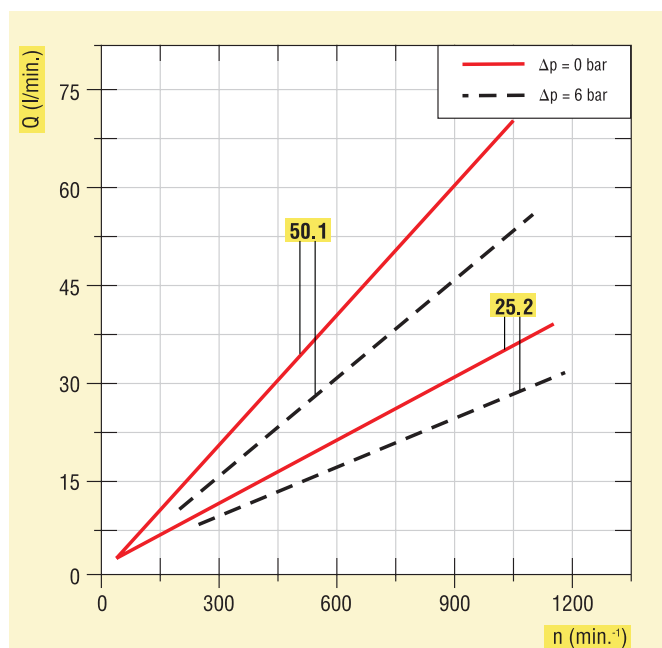

When pumping in „Zone 0“ areas or pumping flammable liquids only pumps with mechanical seal, universal joint shaft and PTFE stator are approved.

Viscosity range from aqueous to fluidity range.
Medium table with liquid examples see chemical resistance table.



Lutz Eccentric Screw Pumps

B70V 75.1

Product detail	Pump tube	B70V
	Size	75.1
	Seal Mechanical seal (MS)	MS
	Drive shaft Universal joint shaft (UJ)	UJ
	Delivery rate*	up to l/min. 75
	Delivery head*	up to bar 8
	Temp. of medium**	up to °C 140
	Material outer tube	1.4571/1.4404
	Immersion tube diameter	up to mm 54
	Pressure joint	Outer thread G 1 1/2
	Weight	kg 7
	Length***	mm 1100
	Stator NBR light (T max. 80 °C)	Order-No. 0173-561
	Stator FPM (T max. 140 °C)	Order-No. 0173-562
	Stator PTFE (T max. 140 °C)	Order-No. 0173-564
<p>* Determined with water at 20 °C, three-phase motor (600 rpm and 700 rpm) and elastomer stator ** with PTFE Stator (the medium temperature of explosion proof eccentric screw pumps B70 may not exceed 100°C) *** The length complies approx. to dimension C in the dimension table. Special length 500 - 2000 mm on request (version with joint shaft only)</p>		
<h3>Motor selection</h3>		
	Motors with cable terminal box	For B70V - 75.1
	Version	1.1 kW, 700 1/min. 1.1 kW, 900 1/min.
	Protection type/weight	IP 55 22 kg IP 55 34 kg
	Order No.	0172+826 0172-903
	Motors with protection switch	For B70V - 75.1
	Version	1.1 kW, 700 1/min.
	Protection type/weight	IP 55 22 kg
	Order No.	0172+825
	Motors with frequency converter	For B70V - 75.1
	Version	1,5 kW, 180-900 1/min.
	Protection type/weight	IP 55 35 kg
	Order No.	0172-913
<p>Three-phase motors 230/400 V, 50 Hz, Energy efficiency category IE 3 in accordance with EU regulations 640/2009 and 04/2014 Special tension, frequency, protection types as well as increased ex-protection classes on request.</p>		
	Compressed air motor	For B70V - 75.1
	Version	8 DA , 1.7 kW, 900 1/min., Weight 18 kg, Operating pressure: at 6 bar, Air consumption 130 Nm ³ /h, 102 db (A)
	Air connection thread	G 1/2
	Order No.	0172-823
<p>Compressed air motors with muffler, max. operating pressure 7 bar, recommended speed (200 - 900 1/min.)</p>		

B70V 75.1

for viscosities from 1 - 100,000 mPas

Materials (coming into contact with the pumped medium):

Version:	B70V 75.1
Housing:	Stainless steel (1.4571/1.4404)
Rotor:	Stainless steel (1.4571)
Seals:	FPM
Mechanical seal:	Carbon/CrMo-casting, FPM
Drive shaft:	Stainless steel (1.4571)
Stator material:	NBR light, FPM, PTFE



Pump tube with PTFE stator, also available in PURE version with Tri-Clamp-connection. You will find more information in our leaflet: Certified solutions for the food, pharmaceutical and cosmetics Industry (Order-No. 0699-315)

Important Information!

Viscosity range from aqueous to fluidity range.
Medium table with liquid examples see chemical resistance table.

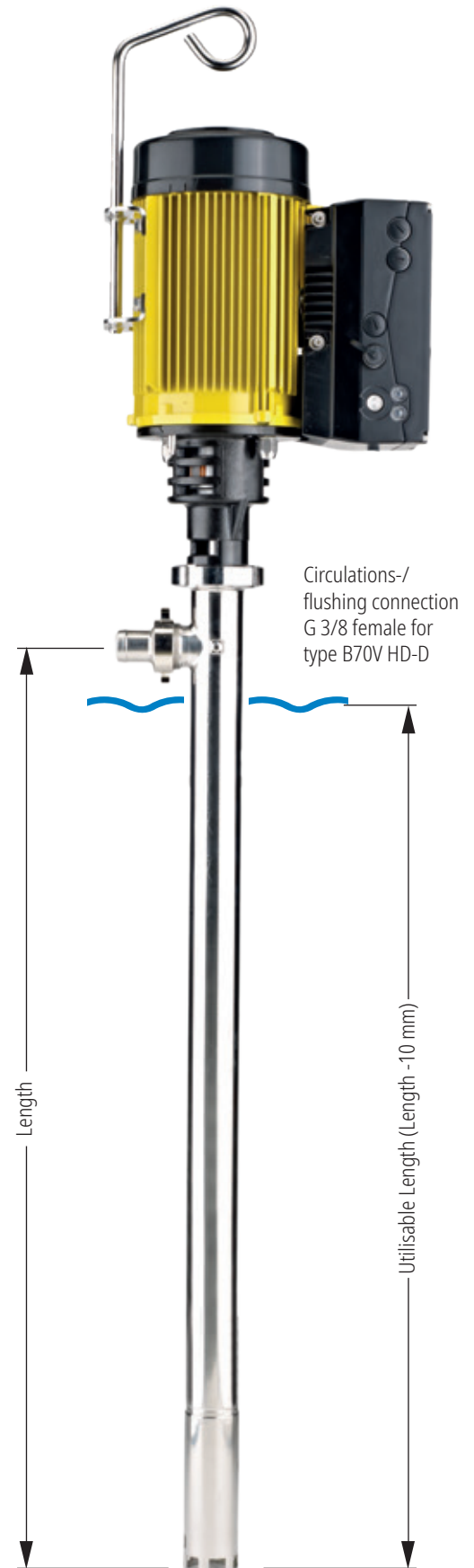
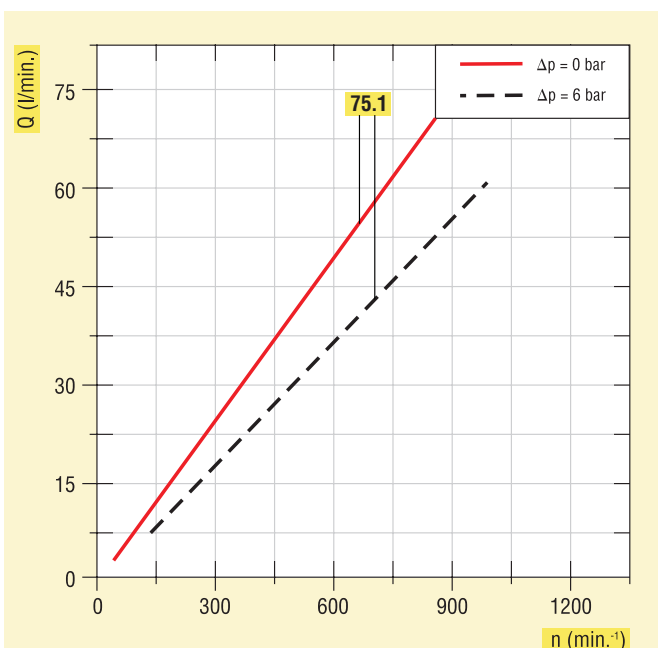

Lutz Eccentric Screw Pumps

B70V 120.1

Product detail



Pump tube **B70V**

Size		120.1
Category 1 / 2 (acc. to ATEX)		no
Seal	Mechanical seal (MS)	MS
Drive shaft	Torsion shaft (TS) Universal joint shaft (UJ)	UJ
Delivery rate*	up to l/min.	120
Delivery head*	up to bar	6
Temp. of medium**	up to °C	140
Material outer tube		1.4571
Immersion tube diameter***	up to mm	131
Pressure joint		Tri Clamp DN 50 (DIN 32676)
Weight	kg	15
Length****	mm	1100
Stator NBR light (T max. 80 °C)	Order-No.	0175-201
Stator PTFE (T max. 140 °C)	Order-No.	0175-204

- * Determined with water at 20 °C, three-phase motor (600 rpm and 700 rpm) and elastomer stator
- ** with PTFE Stator
- *** Equired bung hole Ø 133 mm
- **** The length complies approx. to dimension C in the dimension table. Special length 500 - 2500 mm on request

Choice of motors

Motors with cable terminal box	For B70V - 120.1	
Type	2.2 kW, 600 1/min.	3.0 kW, 600 1/min.
Protection type/Weight	IP 55 43 kg	IP 55 47 kg
Order-No	0175-802	0175-803



Three-phase motors 230/400 V, 50 Hz,
Energy efficiency category IE 3 in accordance with EU regulations 640/2009 and 04/2014.
Special voltages, frequencies, protection types on request.

B70V 120.1

for viscosities from 1 - 120,000 mPas

Materials (coming into contact with the pumped medium):

Version:	B70V 120.1
Housing:	Stainless steel (1.4571)
Rotor:	Stainless steel (1.4571)
Seals:	FPM
Mechanical seal:*	WC/WC, FPM
Drive shaft:	Stainless steel (1.4571)
Stator material:	NBR light, PTFE

* Mechanical seal pairing on request.



Pump tube with PTFE stator, also available in PURE version with Tri-Clamp-connection. You will find more information in our leaflet: Certified solutions for the food, pharmaceutical and cosmetics Industry (Order-No. 0699-315)

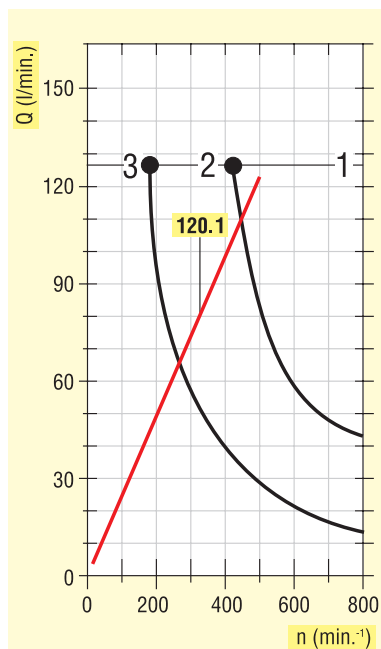

Range 1:

Thin-bodied and lubricating fluids such as wine, milk, oils etc.
 $\eta < 7000$ mPas

Range 2:

Abrasive and viscous fluids such as pulps, adhesives, paints, inks, etc.
 $\eta < 20,000$ mPas

Range 3:

Very abrasive and highly viscous fluids such as honey, greases, syrups, etc.
 $\eta > 20,000$ mPas

Viscosity range:

From aqueous to fluidity range.

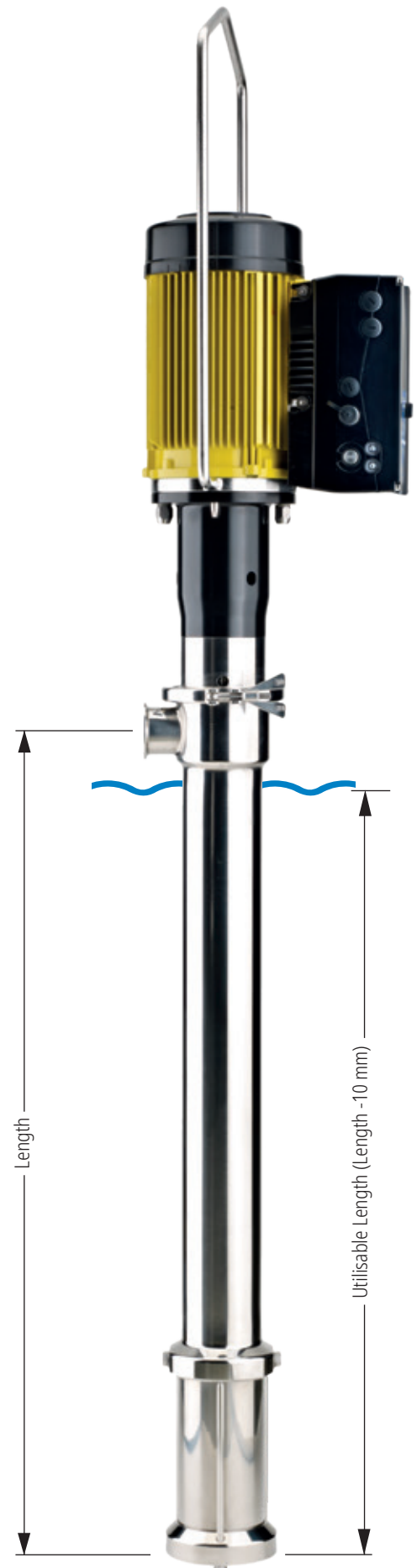
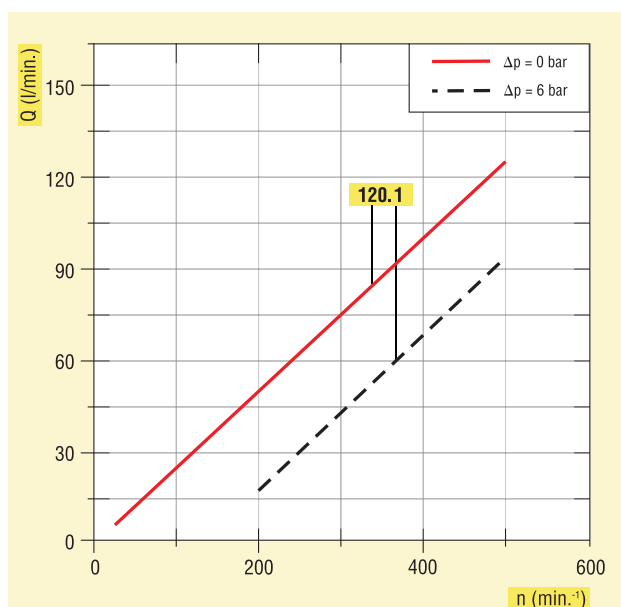

Accessories

Accessories at a glance

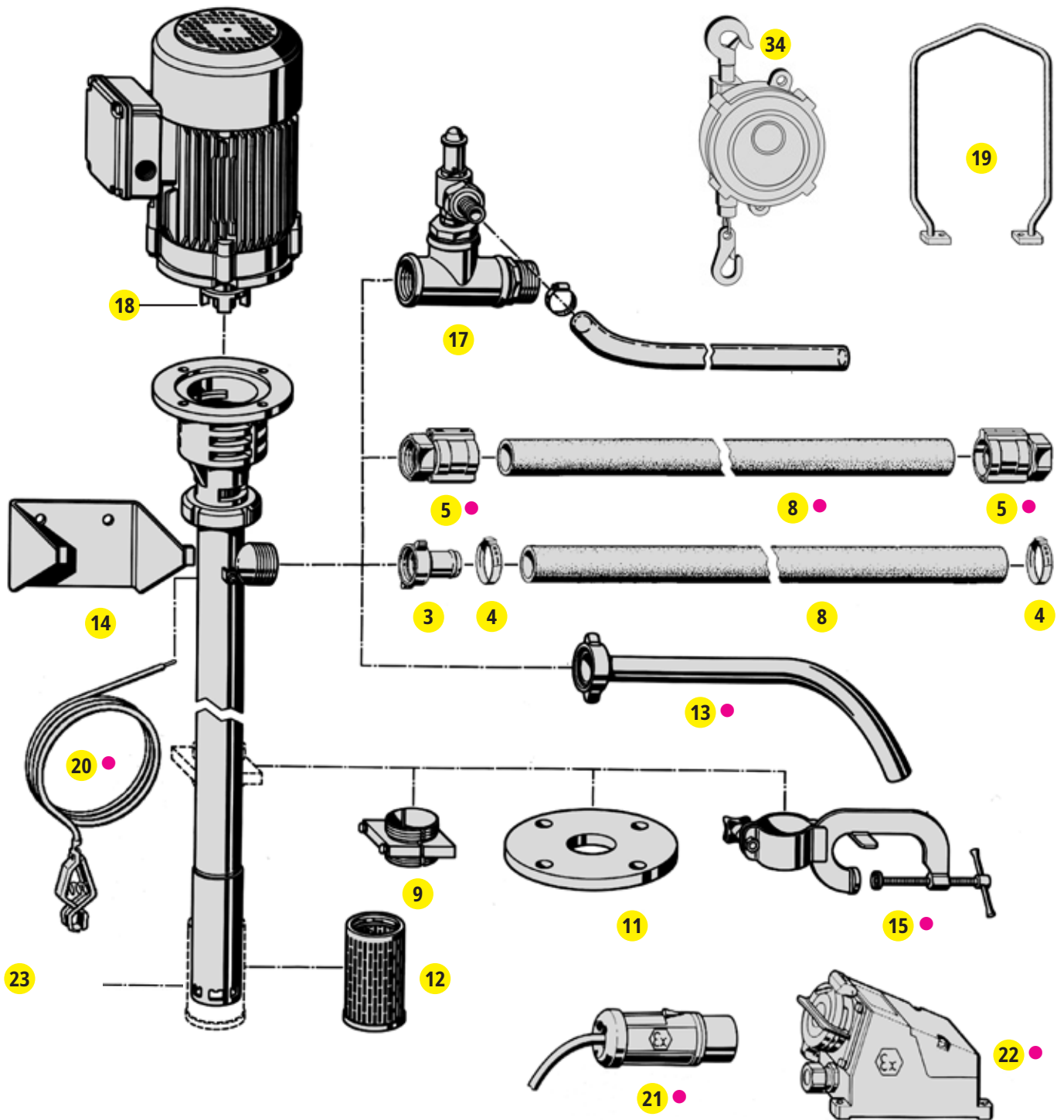

- 3** Hose connection
- 4** Hose clips
- 5** ● Hose connector
- 8** ● Hose
- 9** Drum adapter
- 11** Installation flange







- 12** Foot strainer
- 13** ● Discharge spout
- 14** Wall bracket
- 15** ● Clamping device
- 17** Bypass valve
- 18** Coupling part, motor side

- 19** Lifting device
- 20** ● Equipotential bonding cable
- 21** ● Ex-plug
- 22** ● Ex-socket
- 23** Protection device for drum inliner
- 34** Hoist

● Suitable for transferring combustible and easy inflammable liquids (e.g. ethanol, petrol) or in explosive hazard area.

Specification	Order-No.	Product detail
<p>3 Hose connection</p> <p>For connecting the hoses to the pump tube B70V. Connection thread: G 1 1/2</p> <p>Material: Nominal diameter:</p> <p>Stainless steel DN 25 (1")</p> <p>Stainless steel DN 32 (1 1/4")</p> <p>Stainless steel DN 38 (1 1/2")</p> <p>Aluminium DN 32 (1 1/4")</p>	<p>0204-416</p> <p>0204-417</p> <p>0204-418</p> <p>0204-420</p>	
<p>9 Drum adapter St 37</p> <p>Separable drum adapter for pump tubes with enlarged pump foot. For fixing the pump in the drum opening. Prevents the eccentric screw pump falling over in the empty drum. Thread G 2 and M 64 x 4. for pump tube B70V ø 52 mm</p>	<p>0204-169</p>	
<p>9 Drum adapter PP</p> <p>For fixing the pump in the drum opening. Prevents the eccentric screw pump falling over in the empty drum. for pump tube B70V ø 52 mm</p>	<p>0208-056</p>	
<p>11 Installation flange</p> <p>According to DIN 2576 DN 80. PN 10 For fixing the pump B70V to a companion flange. The flange is welded onto the pump tube. in stainless steel (1.4571)</p>	<p>0170-310</p>	
<p>12 Foot strainer</p> <p>Available in stainless steel, for mounting on the pump foot. Keeps impurities away from the rotating parts. in stainless steel (1.4571)</p>	<p>0204-802 ●</p>	
<p>13 Discharge spout</p> <p>Serving to transfer and fill liquids directly into other vessels. They are available in aluminium and stainless steel and are threaded onto the pump outlet connection.</p> <p>Material: Nominal diameter: Wing nut:</p> <p>Alu DN 25 (1") G 1 1/2</p> <p>SS DN 25 (1") G 1 1/2</p>	<p>0204-374</p> <p>0204-226 ●</p>	
<p>14 Wall bracket</p> <p>For storage of drum pumps.</p> <p>B70V</p> <p>B70V-SR</p>	<p>0204-309</p> <p>0204-307</p>	
<p>15 Clamping device</p> <p>To fasten the eccentric screw pump B70V in open-topped and thick-walled drums and containers. in stainless steel</p>	<p>0205-052 ●</p>	
<p>17 Bypass valve</p> <p>When using a closing valve (nozzle, stop valve etc.) the application of a bypass valve is recommended. (Opening pressure: brass 2.5 bar, stainless steel 5 bar).</p> <p>Connection thread: G 1 1/2</p> <p>Material for pump tube</p> <p>Brass B70V</p> <p>Stainless steel 1.4571 B70V</p> <p>Brass HD-E</p>	<p>0172-640</p> <p>0170-274</p> <p>0155-600</p>	

● Suitable for transferring combustible and easy inflammable liquids (e.g. ethanol, petrol) or in explosive hazard area.

Product detail	Specification	Order-No.																																								
	<p>18 Coupling part, motor side</p> <p>When sourcing your own motor please order the correct coupling to suit the relative shaft diameter.</p> <table border="0"> <tr> <td>Shaft diameter:</td> <td>ø 14 mm</td> <td>for B70V 12.1 up to 75.1</td> <td>0302-028</td> </tr> <tr> <td></td> <td>ø 19 mm</td> <td>for B70V 12.1 up to 75.1</td> <td>0302-027 ●</td> </tr> <tr> <td></td> <td>ø 24 mm</td> <td>for B70V 12.1 up to 75.1</td> <td>0302-026</td> </tr> <tr> <td></td> <td>ø 24 mm</td> <td>for B70V 12.1 up to 75.1</td> <td>0302-215 ●</td> </tr> <tr> <td></td> <td>ø 28 mm</td> <td>for B70V 12.1 up to 75.1 (only in combination with intermediate flange)</td> <td>0302-029</td> </tr> <tr> <td>Intermediate flange for shaft diameter:</td> <td>ø 28 mm</td> <td>for B70V 12.1 up to 75.1</td> <td>0172-782</td> </tr> <tr> <td></td> <td>ø 24 mm</td> <td>for B70V 120.1</td> <td>0302-363</td> </tr> <tr> <td></td> <td>ø 25 mm</td> <td>for B70V 120.1</td> <td>0302-365</td> </tr> <tr> <td></td> <td>ø 28 mm</td> <td>for B70V 120.1</td> <td>0302-364</td> </tr> <tr> <td></td> <td>ø 30 mm</td> <td>for B70V 120.1</td> <td>0302-214</td> </tr> </table>	Shaft diameter:	ø 14 mm	for B70V 12.1 up to 75.1	0302-028		ø 19 mm	for B70V 12.1 up to 75.1	0302-027 ●		ø 24 mm	for B70V 12.1 up to 75.1	0302-026		ø 24 mm	for B70V 12.1 up to 75.1	0302-215 ●		ø 28 mm	for B70V 12.1 up to 75.1 (only in combination with intermediate flange)	0302-029	Intermediate flange for shaft diameter:	ø 28 mm	for B70V 12.1 up to 75.1	0172-782		ø 24 mm	for B70V 120.1	0302-363		ø 25 mm	for B70V 120.1	0302-365		ø 28 mm	for B70V 120.1	0302-364		ø 30 mm	for B70V 120.1	0302-214	
Shaft diameter:	ø 14 mm	for B70V 12.1 up to 75.1	0302-028																																							
	ø 19 mm	for B70V 12.1 up to 75.1	0302-027 ●																																							
	ø 24 mm	for B70V 12.1 up to 75.1	0302-026																																							
	ø 24 mm	for B70V 12.1 up to 75.1	0302-215 ●																																							
	ø 28 mm	for B70V 12.1 up to 75.1 (only in combination with intermediate flange)	0302-029																																							
Intermediate flange for shaft diameter:	ø 28 mm	for B70V 12.1 up to 75.1	0172-782																																							
	ø 24 mm	for B70V 120.1	0302-363																																							
	ø 25 mm	for B70V 120.1	0302-365																																							
	ø 28 mm	for B70V 120.1	0302-364																																							
	ø 30 mm	for B70V 120.1	0302-214																																							
	<p>19 Lifting device</p> <p>To simplify the process of lifting the pump in and out of drums or containers. When using an explosion proof driving motor the Ex-protective plug is mounted onto the lifting device.</p> <p>for pump tube HD-E 0155-154 for B70V-SR with universal motor 0174-607 Additional price for lifting device for motor protective switch (Ex) for pump tubes B70V (Ex) 0172-838</p>																																									
	<p>Motor protective switch for motor B70V</p> <p>Explosion proof according to EEx de IIC T6 with thermal and electromagnetic trip, protection type IP 66. Suitable lifting device for the mounting (item 19).</p> <table border="0"> <tr> <td>Ex, 1.6 - 2.5 A</td> <td>for B70V (Ex)</td> <td>0335-414 ●</td> </tr> <tr> <td>Ex, 2.5 - 4.0 A</td> <td>for B70V (Ex)</td> <td>0335-419 ●</td> </tr> <tr> <td>Ex, 4.0 - 6.3 A</td> <td>for B70V (Ex)</td> <td>0335-420 ●</td> </tr> </table>	Ex, 1.6 - 2.5 A	for B70V (Ex)	0335-414 ●	Ex, 2.5 - 4.0 A	for B70V (Ex)	0335-419 ●	Ex, 4.0 - 6.3 A	for B70V (Ex)	0335-420 ●																																
Ex, 1.6 - 2.5 A	for B70V (Ex)	0335-414 ●																																								
Ex, 2.5 - 4.0 A	for B70V (Ex)	0335-419 ●																																								
Ex, 4.0 - 6.3 A	for B70V (Ex)	0335-420 ●																																								
	<p>21 Ex-plug</p> <p>CEE round plug in accordance with EEx de IIC T6, splash proof in compliance with IP 65.</p> <table border="0"> <tr> <td>3-pole (alternating current) CEAG</td> <td>for B70V-SR (Ex)</td> <td>0336-536 ●</td> </tr> <tr> <td>3-pole (alternating current) STAHL</td> <td>for B70V-SR (Ex)</td> <td>0336-540 ●</td> </tr> <tr> <td>5-pole (three phase current) CEAG</td> <td>for B70V (Ex)</td> <td>0336-537 ●</td> </tr> <tr> <td>5-pole (three phase current) STAHL</td> <td>for B70V (Ex)</td> <td>0336-541 ●</td> </tr> </table>	3-pole (alternating current) CEAG	for B70V-SR (Ex)	0336-536 ●	3-pole (alternating current) STAHL	for B70V-SR (Ex)	0336-540 ●	5-pole (three phase current) CEAG	for B70V (Ex)	0336-537 ●	5-pole (three phase current) STAHL	for B70V (Ex)	0336-541 ●																													
3-pole (alternating current) CEAG	for B70V-SR (Ex)	0336-536 ●																																								
3-pole (alternating current) STAHL	for B70V-SR (Ex)	0336-540 ●																																								
5-pole (three phase current) CEAG	for B70V (Ex)	0336-537 ●																																								
5-pole (three phase current) STAHL	for B70V (Ex)	0336-541 ●																																								
	<p>22 Ex-socket</p> <p>CEE-socket in accordance with EEx de IIC T6, splash proof in compliance with IP 65.</p> <table border="0"> <tr> <td>3-pole (alternating current) CEAG</td> <td>for B70V-SR (Ex)</td> <td>0336-531 ●</td> </tr> <tr> <td>3-pole (alternating current) STAHL</td> <td>for B70V-SR (Ex)</td> <td>0336-542 ●</td> </tr> <tr> <td>5-pole (three phase current) CEAG</td> <td>for B70V (Ex)</td> <td>0336-420 ●</td> </tr> <tr> <td>5-pole (three phase current) STAHL</td> <td>for B70V (Ex)</td> <td>0336-543 ●</td> </tr> </table>	3-pole (alternating current) CEAG	for B70V-SR (Ex)	0336-531 ●	3-pole (alternating current) STAHL	for B70V-SR (Ex)	0336-542 ●	5-pole (three phase current) CEAG	for B70V (Ex)	0336-420 ●	5-pole (three phase current) STAHL	for B70V (Ex)	0336-543 ●																													
3-pole (alternating current) CEAG	for B70V-SR (Ex)	0336-531 ●																																								
3-pole (alternating current) STAHL	for B70V-SR (Ex)	0336-542 ●																																								
5-pole (three phase current) CEAG	for B70V (Ex)	0336-420 ●																																								
5-pole (three phase current) STAHL	for B70V (Ex)	0336-543 ●																																								
	<p>20 Equipotential bonding cable</p> <p>Serves to create electrically conductive connection between explosion proof pump and container as earthing and equipotential bonding function.</p> <p>2 m long with fastening clip 0204-994 ●</p>																																									

● Suitable for transferring combustible and easy inflammable liquids (e.g. ethanol, petrol) or in explosive hazard area.

Specification	Order-No.	Product detail
<p>34 Hoist for eccentric screw pumps, with infinitely adjustable load balancer for easy lifting and moving of the pump.</p> <p>Load bearing capacity: 18-22 kg Tackle: 2 m</p> <p>Load bearing capacity: 22-25 kg Tackle: 2 m</p> <p>Load bearing capacity: 25-30 kg Tackle: 2 m</p>	<p>0371-013</p> <p>0371-014</p> <p>0371-015</p>	
<p>Electronical flow meter, HDO series For metering thin bodied up to highly viscous media – also under high pressures and temperatures. For assembly onto an eccentric screw pump B70V or into a pipeline. Explosion proof flow meter types with Atex approval. See separate leaflet.</p>		
<p>4 Hose clips Stainless steel hose clips with threaded screw for fixing hoses of various nominal bore at the hose connection.</p> <p>Nominal diameter: DN 25 (1") DN 32 - 38 (1 1/4" - 1 1/2")</p>	<p>0301-401</p> <p>0302-402</p>	
<p>5 Hose connector The use of conductive hoses is obligatory in explosion hazard areas. The ohmic resistance between the armatures must be less than 10⁶ ohm. The hose connection must ensure a highly conductive transition between hose and pump tube.</p> <p>Brass for hose DN 32 (1 1/4") inner thread G 1 1/2 (EN 12 115) for hose DN 38 (1 1/2") inner thread G 1 1/2 (EN 12 115) for hose DN 50 (2") inner thread G 2 (EN 12 115)</p> <p>Stainless steel (1.4571) for hose DN 32 (1 1/4") inner thread G 1 1/2 (EN 12 115) for hose DN 38 (1 1/2") inner thread G 1 1/2 (EN 12 115) for hose DN 50 (2") inner thread G 2 (EN 12 115)</p>	<p>0302-090 ●</p> <p>0302-091 ●</p> <p>5000-100 ●</p> <p>0302-096 ●</p> <p>0302-092 ●</p> <p>5000-101 ●</p>	

● Suitable for transferring combustible and easy inflammable liquids (e.g. ethanol, petrol) or in explosive hazard area.

Product detail

Specification

Order-No.

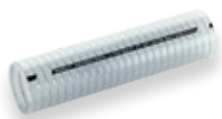

8 PVC spiral hose, fabric reinforced

Hose made of PVC, with woven layer and imbedded galvanized steel helix.
For aggressive, non-flammable liquids.

Operating pressure:	max. 14 bar
Temperature of medium:	-5 up to +65 °C
Nominal diameter:	Weight:
DN 25 (1")	0.67 kg/m
DN 32 (1 1/4")	0.80 kg/m
DN 38 (1 1/2")	1.15 kg/m
DN 50 (2")	1.60 kg/m

0374-467*
0374-468*
0374-469*
0374-470*

*Hose for food liquids, inside and outside smooth, complies with EU-regulations 10/2011 and 1935/2004.



8 Mineral oil hose

Colour coding: "yellow".

Hose for mineral oil products of all kinds and super up to 50 % aromatics and methanol content.
Inner rubber NBR (conductive) and outer rubber NBR (not conductive).

Electrically conductive: Type Ω-CL (<10⁶ Ohm between the fittings) according to TRbF 50 appendix B (TRbF 131/2).

Operating pressure:	max. 10 bar
Temperature of medium:	-25 up to +65 °C
Nominal diameter:	Weight:
DN 25 (1")	0.5 kg/m

0374-462 ●

Hose for mineral oil products of all kinds and super up to 50 % aromatics and methanol content.
Inner rubber NBR and outer rubber chloroprene (CR).

Electrically conductive: Type Ω/T (<10⁶ Ohm between the fittings,
<10⁹ Ohm through the hose wall) according to DIN EN 12115:2011.

Operating pressure:	max. 16 bar
Temperature of medium:	-30 up to +90 °C
Nominal diameter:	Weight:
DN 32 (1 1/4")	1.0 kg/m
DN 38 (1 1/2")	1.2 kg/m

0374-413 ●
0374-414 ●



8 Solvent hose

Colour coding: "blue".

Hose suitable for a wide range of commercial solvents.

Inner rubber of special coating and outer rubber of NBR/PVC-Compound
(from DN 32 with galvanized steel helix it is suitable as suction and pressure hose).

Electrically conductive: Type Ω/T (<10⁶ Ohm between the fittings,
<10⁹ Ohm through the hose wall) according to DIN EN 12115:2011.

Operating pressure:	max. 16 bar
Range of temperature:	-20 up to +80 °C (dependant on the liquid), steaming out up to 130 °C for max. 30 minutes (open ends)

Nominal diameter:	Weight:
DN 25 (1")	0.8 kg/m
DN 32 (1 1/4")	1.2 kg/m
DN 38 (1 1/2")	1.4 kg/m

0374-417 ●
0374-418 ●
0374-450 ●

● Suitable for transferring combustible and easy inflammable liquids (e.g. ethanol, petrol)
or in explosive hazard area.

Specification	Order-No.	Product detail
<p>8 Universal chemical hose</p> <p>Colour coding: "blue/white/blue". Suitable for clean chemicals, cosmetics, photo-chemicals, paints and glues, washing and cleaning products, hygienic products as well as foodstuffs and luxury foodstuffs, (for more information see resistance table). Conform to FDA and USP class VI. Complies with EU-regulations 10/2011 and 1935/2004. Internal finish: UPE light with spiraled OHM conductive stripes UPE black, smooth, non-bleeding, abrasion-resistant. Intermediate layer: EPDM conductive (complies with the requirements of the recommendation XXI category 2 of the BfR and FDA standards). External finish: EPDM light grey, conductive, non-bleeding, ozone- and UV resistant, hardly inflammable, (starting from DN 25 with galvanized steel helix, suitable as suction and pressure hose). Electrically conductive: Type Ω/T ($<10^6$ Ohm between the fittings, $<10^9$ Ohm through the hose wall) according to DIN EN 12115:2011.</p> <p>Operating pressure: max. 16 bar Range of temperature: -30 up to +100 °C (dependant on the liquid), steaming out up to 130°C for max. 30 minutes (open ends)</p> <p>Nominal diameter: Weight: DN 25 (1") 0.8 kg/m DN 32 (1 1/4") 0.9 kg/m DN 38 (1 1/2") 1.2 kg/m</p>	<p>0374-476 ● 0374-477 ● 0374-478 ●</p>	
<p>8 Special chemical hose FEP</p> <p>Colour coding: "blue/white/red". Suitable for all commonly used media, ideal also for very pure products. Suitable as suction and pressure hose. Internal finish: FEP transparent, smooth, seamless, non-leaching, non-dyeing, not electrically conductive (in conformity with FDA and USP Class VI demands). External finish: EPDM electrically conductive. Light grey with OHM conductive stripes, with galvanized steel helix. Electrically conductive Type $\Omega-C$ ($<10^6$ Ohm between the fittings) according to DIN EN 12115:2011. (NOT suitable for non-conductive, flammable liquids)</p> <p>Operating pressure: max. 16 bar Range of temperature: -30 up to +100 °C (dependant on the liquid), steaming out for cleaning and sterilisation permissible up to 150°C for max. 30 minutes (open ends)</p> <p>Nominal diameter: Weight: DN 25 (1") 1.0 kg/m DN 32 (1 1/4") 1.1 kg/m DN 38 (1 1/2") 1.5 kg/m</p>	<p>0374-429 0374-430 0374-455</p>	
<p>Special chemical hose PTFE</p> <p>Colour coding: "blue/white/red". Suitable for all commonly used media, ideal also for very pure products. Suitable as suction and pressure hose. Internal finish: PTFE black, smooth, seamless, electrically conductive (conform to FDA and USP class VI. Complies with EU-regulations 10/2011 and 1935/2004). External finish: EPDM electrically conductive. Black, galvanized steel helix. Electrically conductive: Type Ω/T ($<10^6$ Ohm between the fittings, $<10^9$ Ohm through the hose wall) according to DIN EN 12115:2011.</p> <p>Operating pressure: max. 16 bar Range of temperature: -30 up to +150 °C (dependant on the liquid), steaming out for cleaning and sterilisation permissible up to 150°C for max. 30 minutes (open ends)</p> <p>Nominal diameter: Weight: DN 25 (1") 1.0 kg/m</p>	<p>0374-482 ●</p>	
<p>23 Protection device for drum inliner</p> <p>For mounting onto the pump foot. Protects sensitive drum inliner and bags from damage. For pump tube B70V 120.1</p>	<p>0175-332</p>	

● Suitable for transferring combustible and easy inflammable liquids (e.g. ethanol, petrol) or in explosive hazard area.

Accessories

Contact-free indirect measurement



Product detail

Specification

Order-No.

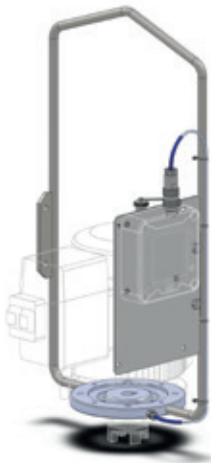

1 Lifting device with integrated impulse sensor

Comprises of:

Impulse sensor with connecting cable and 14-wire coupling plug, lifting device and flange plate.
(Please order suitable impulse transmitter and control unit additionally)

Additional price* for three-phase motors up to 1.1 kW

0172-891

Additional price* for three-phase motors up to 1.5 kW
and explosion proof three-phase motors Ex

0172-892 ●

Complete set for retrofitting available pumps

0172-890 ●

*(Please indicate Ref. No. for additional price when ordering a pump)

2 Impulse transmitter

Must be ordered additionally suitable for the shaft diameter of the motor.

For shaft diameters:

Ø 19 mm

0172-824

Ø 20 mm

0172-825

Ø 24 mm

0172-826

Ø 25 mm

0172-827



Ø 28 mm

0172-828

Ø 30 mm

0172-829

● Suitable for transferring combustible and easy inflammable liquids (e.g. ethanol, petrol)
or in explosive hazard area.

Specification	Order-No.	Product detail
<p>3 Control unit with touch screen display and menu-navigated operation. Is intended for evaluation of impulses and display of flow volume, battery-operated**</p> <p>Control unit BE10 Control unit Ex BE10B</p> <p>Power supply unit NG10 230 V for external power supply of the operating unit 220-240 V, 50-60 Hz, II (2) G [Ex ib Gb] IIC</p>	<p>0230-000 0230-010 ●</p> <p>0230-230</p>	
<p>Accessories optional</p> <p>Relay module RM30 For three-phase motors up to 1.5 kW allows the filling with pre-selection (batch function), 400 V, 1.5 kW, 50 Hz, II (2) G [Ex ib Gb] IIC</p> <p>Power cable RM30 400V 400 V, 50 Hz, 5-wire, 5 m long</p> <p>Connecting cable motor RM30 400V 400 V, 50 Hz, 5-wire, 0.6 m long</p> <p>Relay module RM10 For three-phase motors with frequency converter allows the filling with pre-selection (batch function), 220-240 V, 50-60 Hz, II (2) G [Ex ib Gb] IIC</p> <p>Power cable RM10 230V 230 V, 50 Hz, 5 m long</p> <p>Adapter cable motor RM-FU 230V/24V For three-phase motors with frequency converter 230V AC/24V DC</p>	<p>0230-220</p> <p>0211-388</p> <p>0211-386</p> <p>0230-200</p> <p>0211-155</p> <p>0230-323</p>	

** Limited battery operation without power supply unit possible

Twice the **COMPETENCE...**



Professional Fluid Management

Drum pump sets

Drum and container pumps

Eccentric screw drum pumps

Flow meter systems

Air operated double diaphragm pumps

Vertical and horizontal centrifugal pumps

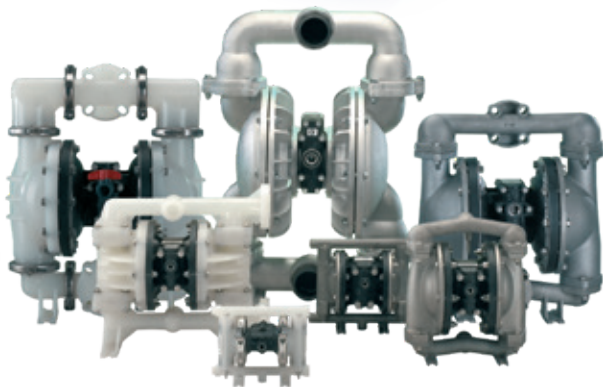

Lutz Pumpen GmbH

Erlenstraße 5-7 · D-97877 Wertheim · Phone: (+49 93 42) 8 79-0 · Fax: (+49 93 42) 87 94 04 · E-Mail: info@lutz-pumpen.de

www.lutz-pumpen.de

...simply **UNIQUE**



A Measured Step Forward



Dosing pumps and accessories

Chlorinators

Measuring and control technology

System and process technology

Chemical centrifugal pumps

Water disinfection

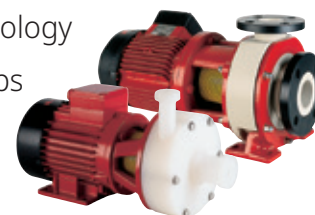

Lutz-Jesco GmbH

Am Bostelberge 19 · D-30900 Wedemark · Phone (+49 51 30) 58 02-0 · Fax (+49 51 30) 58 02 68 · E-Mail: info@lutz-jesco.com

www.lutz-jesco.com



Lutz Pumpen GmbH

Erlenstraße 5-7
D-97877 Wertheim
Phone: (+49 93 42) 8 79-0
Fax: (+49 93 42) 87 94 04
E-Mail: info@lutz-pumpen.de

www.lutz-pumpen.de

Now to the newsletter
and never miss any news!



**Follow
us on:**

